

BSR-1000, BSR-1001, BSR-1002, BSR-1004

Analogue Addressable Fire Alarm Panel 1, 2 and 4 loops

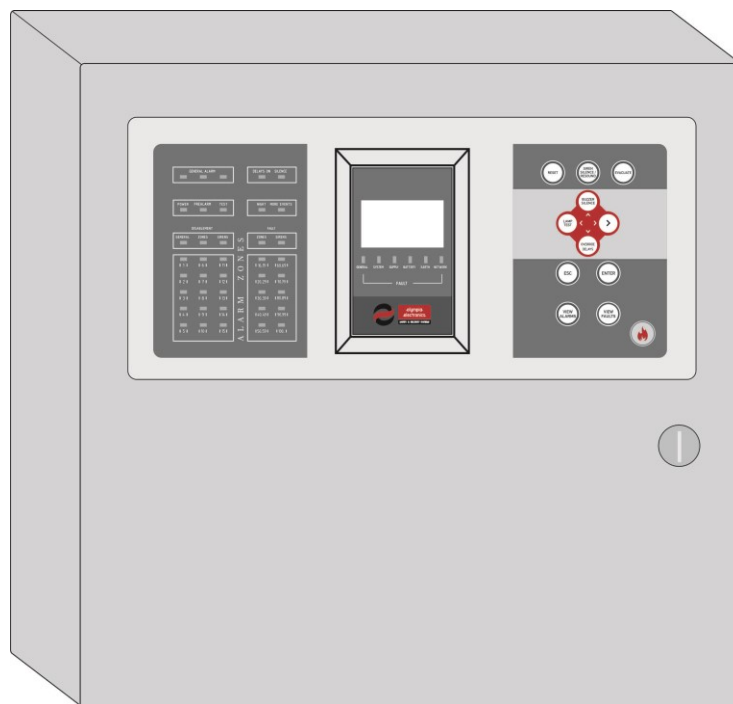

**Installation
Programming
Operation**

WARNING!!! READ THIS MANUAL PRIOR TO ANY INSTALLATION OR USE

Index

1 General Information	5
1.1 General description	5
1.2 Safety	5
1.3 Indicators and Controls	6
1.3.1 Control panel's front	6
1.3.2 Control panel's keypad	7
1.3.3 LED indicators	8
2 Functions	10
2.1 Control panel operating states	10
2.2 Quiescent state	10
2.3 Prealarm state	10
2.4 Alarm state	11
2.5 Fault state	11
2.6 Access Level Functions 1 (Access Level 1)	12
2.7 Basic access level menu 1 (Access Level 1)	12
2.7.1 Events menu	13
2.7.2 Test LED	13
2.7.3 Information	14
3 User's Menu	19
3.1 Enable / Disable segments	21
3.2 Delays Menu	22
3.3 Set Date / Time	22
3.4 Backlight mode	23
3.5 Change user's code	23
3.6 PC Communication	24
3.7 Operating via PC (Ethernet)	25
3.7.1 Control panel web interface	25
3.7.2 View current alarms, faults and prealarms	25
3.7.3 View disablement	26
3.7.4 Information	26
3.7.5 All events	29
3.7.6 User's menu	29
4 Installation	30
4.1 Safety	30
4.2 Installation	30
4.3 Control panel installation	31
4.3.1 Description of the interior of the panel	31
4.3.2 Placing the panel on wall	31
4.3.3 Connecting the mains power supply cable (220-240V AC)	32
4.3.4 Connecting the batteries	33
4.4 Wiring	34
4.4.1 Loop Connections	35

4.4.2	Connecting conventional sirens	38
4.5	Panel network connections	39
4.6	General connections diagram	40
4.7	Other connections	41
5	Technician Menu	43
5.1	Test Menu	45
5.1.1	Walk test	45
5.1.2	All zones in test	45
5.1.3	All zones out of test	45
5.1.4	Device LED Address	46
5.2	Check Menu	46
5.2.1	Check points	46
5.2.2	Check loop communication	47
5.2.3	Check conventional sirens	47
5.2.4	Check relays	47
5.2.5	Check voltage outputs	48
5.2.6	Check network panels	48
5.3	Setup menu	49
5.3.1	Points	49
5.3.2	Point detection	49
5.3.3	Autoaddressing points	50
5.3.4	Change point address	51
5.3.5	General resound	51
5.3.6	Conventional sirens	51
5.3.7	AUX Relay	52
5.3.8	Extra Relays	52
5.3.9	Panel Network	53
5.3.10	Loops	54
5.3.11	Max indicators per loop	54
5.3.12	Detectors dependency	54
5.3.13	Indication of points	55
5.3.14	Delete points	55
5.4	General settings	55
5.4.1	Select language	55
5.4.2	Change technician code	56
5.4.3	External PCB function	56
5.4.4	Select MODBUS address	56
5.4.5	Ethernet adaptor	56
5.4.6	Annual check warning	57
5.4.7	Annual check done	57
5.4.8	Annual check date	58
5.4.9	Reset defaults	58
5.5	Clear events log	58
5.6	Initializing alarm counter	58
5.7	PC Communication	59
5.8	Technician's Menu on Ethernet	59
5.8.1	Change information	60
6	Initial installation procedure	61

7 BSR-100X PC software application -----	63
7.1 Programming the panel-----	63
7.2 Loop calculation-----	66
7.3 Battery Calculation-----	67
8 BSR-1000 Repeater panel -----	67
8.1 General-----	67
8.2 Functions-----	68
8.3 Installation-----	68
8.4 Wiring-----	68
8.5 Setup repeater network-----	68
8.5.1 Setup repeater address-----	68
8.5.2 Panel network detection-----	68
9 Technical Characteristics – Properties -----	69
9.1 Factory default settings-----	70
9.2 EN 54-2 implemented optional paragraphs-----	71

 olympia electronics <small>SAFETY & SECURITY SYSTEMS</small> <i>for a safer world!</i>	Date	9/6/2022
	Document number	921100400_09_005
	Page	5 of 71

1 General Information

Thank you for your trust in our products
Olympia Electronics – European manufacturer

1.1 General description

The **BSR-100X** series of **Analogue Addressable Fire Alarm Panels** consists of 3 models (1, 2 and 4 loop connections), named **BSR-1001**, **BSR-1002** and **BSR-1004** respectively, all sharing the same control interface, functionality and indications. The accompanying software application for Windows PC, **BSR-100X** provides utilities for calculating installation parameters, configuring the control panel and keeping an event log record.

All BSR-100X models include 4 outputs for conventional sirens, an alarm relay, a fault relay and a programmable auxiliary relay. Two 12V lead acid (Pb) batteries are required in each control panel. The supported battery capacity is 7Ah, 9Ah, 12Ah or 15Ah, which must be calculated in accordance with the size of the installation (number of devices) and the required emergency duration (during mains interruption). It is always recommended to use the “**Battery Calculator**” tool (included in BSR-100X software app) to calculate the required battery capacity according to your installation needs.

The available loop output connections are: 1 for BSR-1001, 2 for BSR-1002 and 4 for BSR-1004. Each loop output connection can support up to 150 addressable units (smoke and heat detectors, addressable sirens, manual fire call points, etc.). The “**Loop Calculator**” tool (included in BSR-100X software app) shall be used for cable selection according to your installation size.

All features and indications are in accordance with European standards EN 54-2 and EN 54-4.

The BSR-100X series Analogue Addressable Fire Alarm Panels is ideal for medium to large scale facilities such as department stores, hotels and factories.

An extended variety of settings and functionalities for controlling the fire alarm system (such as sirens, output relays and other) under certain events (by zone or task), is available via the software BSR-100x (for Windows PC). The communication between PC and control panel is via a USB cable.

The repeater BSR-1000 along with the BSR-100x fire detection panel series, allow the user to execute basic functions for controlling, monitoring as well as reading the event log of the system. All, through the built-in keypad and the LCD graphic display.

1.2 Safety

To ensure proper use of a device all accompanying documents must be read carefully.

This product must be installed, commissioned and maintained by **trained technician personnel** in accordance with:

- The regional regulations for the installation of electrical appliances in buildings
- The regional Fire Safety regulations
- Manufacturer's instructions

-The device mains power supply is rated at 220-240V AC / 50-60Hz, being a **Class I** product (the corresponding terminal contact with the “Protective Earth” ⚡ marking, inside the device, must be connected to the building’s ground to ensure proper function and safety).

- Being a type B equipment (permanently connected to mains) the mains power supply to the device must be connected to the existing building’s electrical installation, with its own separate power line and circuit-breaker rated at 16A, labeled with "**Fire Detection System - Do not switch off**".

1.3 Indicators and Controls

The control panel's LCD screen displays information regarding the current state of the fire detection system. The front face is also equipped with LED indicators for essential indications (alarm, fault, status, zones, etc.).

On the right side of the front face there is an 11-key keypad for controlling and configuring the fire detection control panel.

The following picture describes in general:

1.3.1 Control panel's front

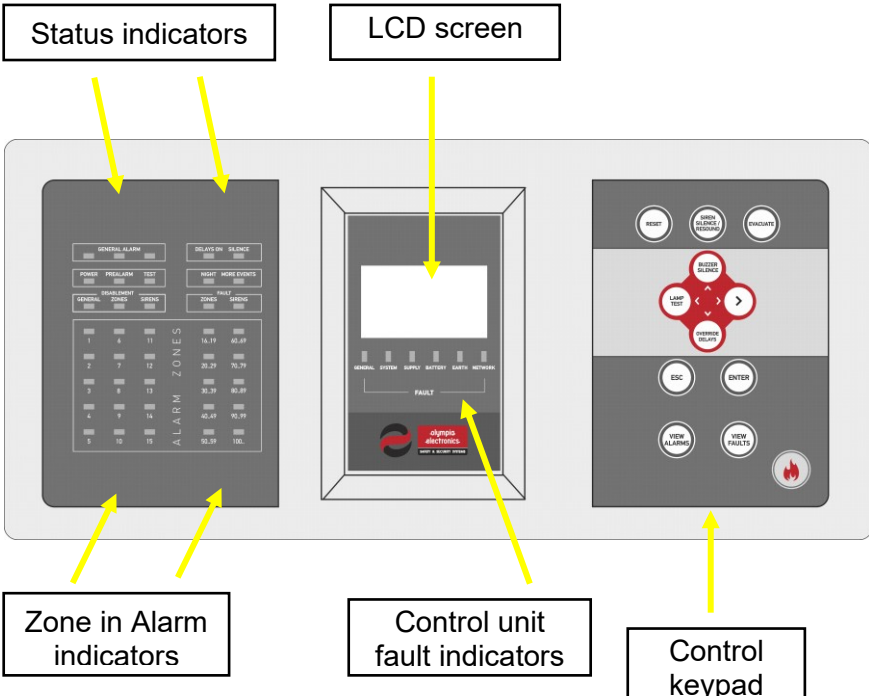

The diagram shows the front face of the control panel. On the left, there are 'Status indicators' and 'Zone in Alarm indicators' (a grid of LEDs). In the center is the 'LCD screen' displaying system information. On the right is the 'Control keypad' with 11 keys: a top row with 'RESET', 'SIREN SILENCE/RESOUND', and 'EVACUATE'; a central red directional pad with 'LAMP TEST' and 'CHECK RELAYS'; and a bottom row with 'ESC', 'ENTER', 'VIEW ALARMS', and 'VIEW FAULTS'. A fire icon is also present at the bottom right. Labels with arrows point to these components.

The control panel's front is equipped with LED indicators and an LCD screen that provide essential information regarding the fire detection system state. The LED indicators provide general information (e.g. if there is any alarm, the General Alarm LEDs are lit), while more detailed information is displayed on the screen (e.g. ALARM 1, ROOM 214).

Next to the screen there are 11 control keys to operate the panel. These keys correspond to basic panel operations, such as left, right, up, down, enter (select), esc (exit or a level back), or back. There are also 5 special keys with specific functions (Reset, Siren Silence/Resound, Evacuate, View alarms, View faults)

Generally, by pressing a key, an action takes place (e.g. Reset), or a menu with grouped functions is displayed (see section 1.3.2).

The control panel's front door is secured with a key lock for accessing the interior.

Figure1-1. Control panel's front

1.3.2 Control panel's keypad

	RESET	Resets the panel from alarm state to quiescent, clears current faults
	SIREN SILENCE / RESOUND	Stops or resumes sirens during alarm mode
	EVACUATE	Evacuation of the building. Manual activation of all alarm outputs
	BUZZER SILENCE	Mutes / unmutes audible buzzer
	LAMP TEST	Turns on all LED indicators for 5 seconds to visually inspect for functionality
	OVERRIDE DELAYS	Immediately activates all alarm outputs (sirens, relays) ignoring the pre-set delays, during an alarm event (Access level 2)
	ESC	Go to previous menu – Exit
	ENTER	Confirm selection
	VIEW ALARMS	View current alarms (when available)
	VIEW FAULTS	View current faults (when available)
	ARROWS	Menu navigation keys (up / down / left / right) – move to selections, input values (up – increase / down – decrease)

Figure1-2. Control panel's keypad

1.3.3 LED indicators

The LED indicators are divided into groups, according to their purpose. Their color also define their event type, red LEDs indicate alarm, yellow LEDs indicate status or fault, green LED indicates the mains power. In details, LEDs from top to bottom are:

	GENERAL ALARM		red	System is in fire alarm state
	DELAYS ON		yellow	Delays have been set for one or more outputs
	SILENCE		yellow	Sirens and relay outputs have been temporarily deactivated (during alarm state)
	POWER		green	Mains power connection indication (steady lit – ok / blinking – power down)
	PREALARM		yellow	Prealarm detected
	TEST		yellow	The system or part of it is under test, fire detection is bypassed
	NIGHT		yellow	Operating mode "NIGHT" (alarm value triggering may differ)
	MORE EVENTS		yellow	More events than those displayed on home screen are active
	DISABLEMENT	GENERAL	yellow	General indicator of deactivated segments
		ZONES	yellow	One or more zones are disabled
		SIRENS	yellow	Sirens disabled
	FAULT	ZONES	yellow	Fault in zone
		SIRENS	yellow	Fault in siren
	ALARM ZONES		red	Alarm in the corresponding zone, for the first 15 zones. The rest 113 zones are grouped into the next 10 LED indicators.

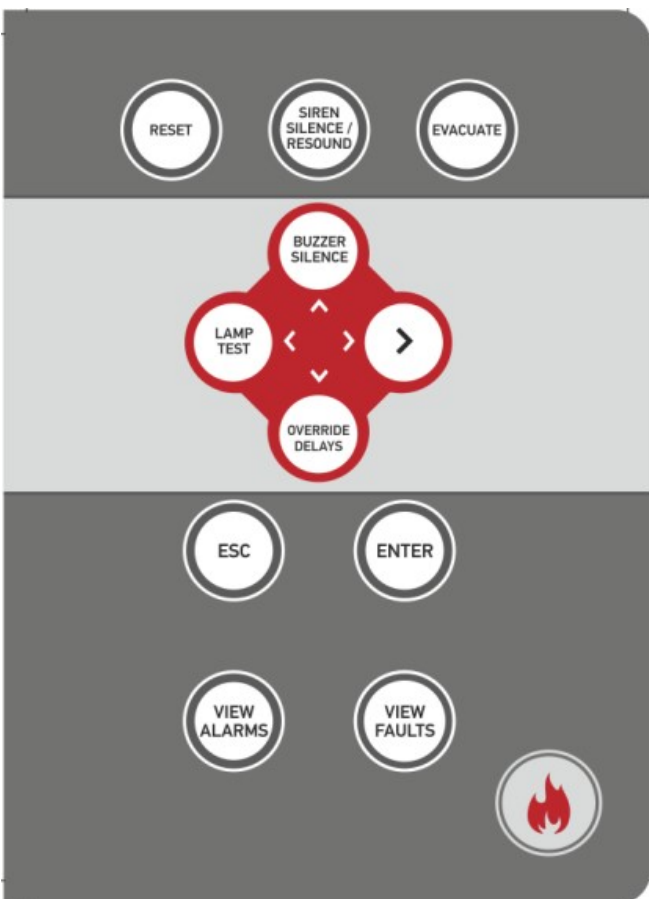
Figure1-3.LED indicators

On the figure below appear the LED indicators below the screen. All of them refer to specific faults of the control panel (according to the description) and are yellow.

	GENERAL FAULT	General panel fault
	SYSTEM FAULT	System fault (hardware)
	SUPPLY FAULT	Power failure (mains)
	BATTERY FAULT	Battery fault
	EARTH FAULT	Unintended connection of power circuit conductors with the earth
	NETWORK FAULT	Panel network communication fault

Figure1-4. LED Indicators below the screen

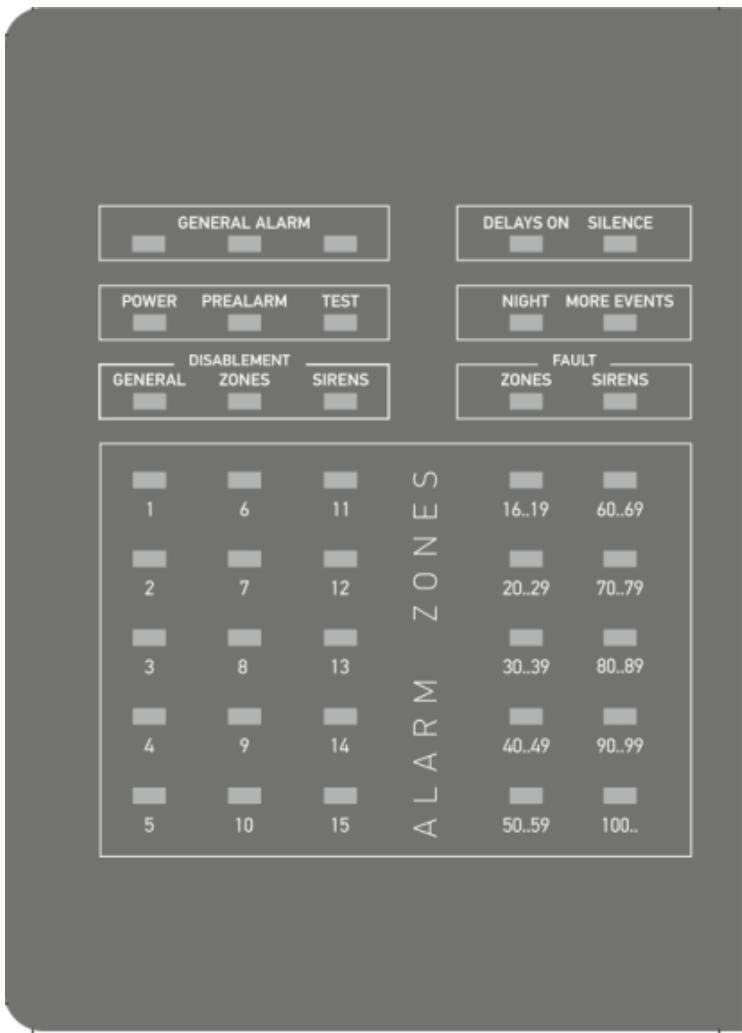
2 Functions

2.1 Control panel operating states

The operating states of the control panel are the following:

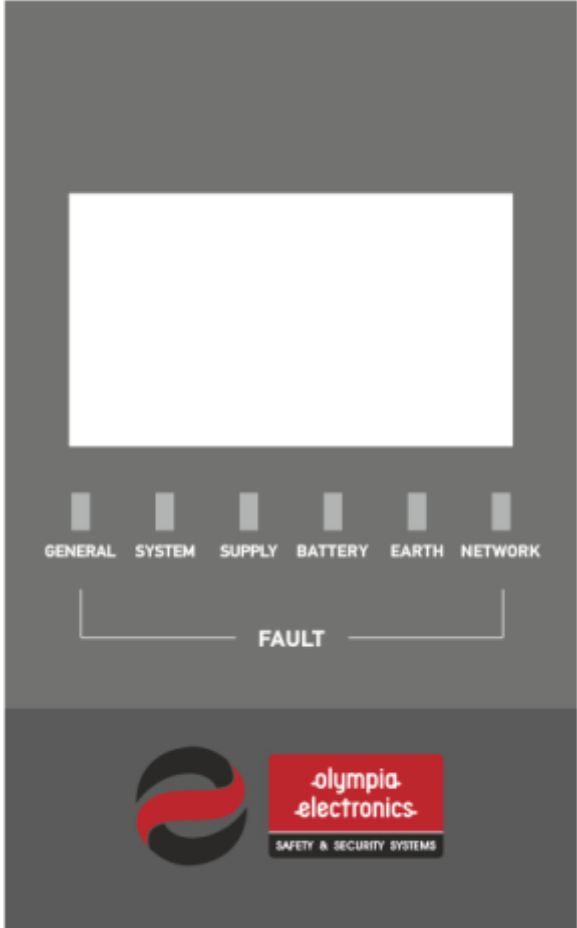
- A) Quiescent
- B) Prealarm
- C) Alarm
- D) Fault

2.2 Quiescent state

The state where there are not any current alarms, prealarms or fault events is called quiescent state. The message “**SYSTEM READY**” is shown on the second row and the status is stated as “**QUIESCENT**”. A typical screenshot when in quiescent state is shown below:

BSR-100x	4 LOOPS
SYSTEM READY	
STATUS : QUIESCENT	
1 DISABLED	
14:25	MO 24/02/18

Figure 2-1. Example of quiescent state main screen

The first row indicates how many loops are installed, 1, 2 or 4.

On the fourth row, the following information appears, when available (alternating every 3 seconds):

- The control panel address and the name of it when panel network is enabled
- The number of the segments under test (if any)
- The number of the disabled segments of the system (if any)
- The number of current faults on the system (if any – FAULT STATE)

Else this row is empty.

When in quiescent state, the “**POWER**” indicator (green) on the left side is lit. Indicators such as “**DISABLEMENT**”, “**FAULT**”, “**NIGHT**” or “**DELAYS ON**” might also be lit according to settings or state.

2.3 Prealarm state

If a detection device triggers a prealarm signal, the yellow “**PREALARM**” indicator is being lit, and the buzzer is beeping. Pressing “**BUZZER SILENCE**” will mute the buzzer until a new event appears. The second row indicates the message “**X - PREALARMS**” where X represents the number of current prealarms.

BSR-100x	4 LOOPS
1-PREALARM	
STATUS :	
1 PREALARM	
14:25	MO 25/02/18

Figure 2-2.Prealarm on main screen

2.4 Alarm state

If a detection device triggers a fire alarm signal, the red "**GENERAL ALARM**" indicator is being lit. On the first row the message "**X – ALARMS**" is shown, where X represents the number of the current alarms.

2-ALARMS	
FIRST :	POINT Z-1
	POINT 1.003
LAST :	POINT Z-1
	POINT 1.0012
14:25	MO 25/02/18

Figure 2-3.Alarm on main screen

The second and the third row, describe the first and the last alarm event respectively. The name of the point that triggered the alarm event, its zone and its loop & address are displayed.

Once the alarm state is activated, the built-in buzzer will play a long beeping sound and all outputs set to operate in alarm mode will be activated. Pressing "**BUZZER SILENCE**" key will mute the buzzer until a new event appears. Pressing "**SIREN SILENCE**" key will deactivate all sirens, as long as all other output relays that are set to behave respectively under silence command.

To view all current alarms, press "**VIEW ALARMS**" key and navigate with up/down arrow.

2.5 Fault state

Similar to quiescent state, there is the fault state, when a fault appears. In fault state, the yellow "**GENERAL FAULT**" indicator is lit, the built-in buzzer will sound and the fault relay will be triggered. In the meanwhile, other LED indicators that refer to segments under fault may also be lit.

On the third row, additional information about the fault will appear, regarding its source. If there are more faults, information about all the faults will be alternated.

BSR-100x	4 LOOPS
SYSTEM READY	
FAULT,	POINT
	DISCONNECTED
2 FAULTS	
14:25	MO 24/02/14

Figure 2-4.Fault on main screen

Pressing "**BUZZER SILENCE**" will mute the buzzer until a new event appears

To view all current alarms, press "**VIEW ALARMS**" key and navigate with up/down arrow.

2.6 Access Level Functions 1 (Access Level 1)

This level refers to the functions that a simple user can do directly via the keypad while on main screen. No code (password) is required for these functions

- **“BUZZER SILENCE”**: On the event of a fault, or an alarm, if this key is pressed, the built-in buzzer stops sounding. As long as the event is present, the buzzer makes a short burst sound every 30 seconds. If a new event appears, the buzzer will start sounding again.
- **“LAMP TEST”**: By pressing this key, all LED indicators are being lit for 5 seconds, in order to confirm functionality.
- **“OVERRIDE DELAYS”**: If alarm state is active and the delays are enabled, the user can override the delays by pressing this key. The outputs will be activated instantly, bypassing all user programmed delays.
- **“VIEW ALARMS”**: In alarm state, if this key is pressed, all current alarms are displayed. More details are provided in the next paragraph.
- **“VIEW FAULTS”**: When there is one or more fault events, if this key is pressed, all current faults are displayed. More details are provided in the next paragraph.

2.7 Basic access level menu 1 (Access Level 1)

When in the main screen, by pressing Enter key the screen displays the main menu as shown below:

MENU
VIEW DISABLEMENT
USER MENU
TECHNICIAN MENU
ALL EVENTS
INFORMATION
TEST LED

Figure 2-5.Main menu

IMPORTANT! When in alarm state, the first option will be **“CURRENT ALARMS”**. When in prealarm state, the first option will be **“CURRENT PREALARMS”**. When in fault state, the first option will be **“CURRENT FAULTS”**. If there are disabled segments, the first option will be **“VIEW DISABLEMENT”**. If more than the states above are active, their options will appear in the priority order mentioned above.

Normally, on quiescent state, the available options will be those on figure 2-5 (Main menu)

More information regarding the options in the main menu:

- **VIEW DISABLEMENT:** View all disabled segments of the fire detection system.
- **USER MENU:** This menu includes a set of settings only accessible by user with access level “2”.
- **TECHNICIAN MENU:** This menu includes a set of settings, special functions and hardware parameters for setting up and commissioning the panel. This menu is only accessible by technician personnel with access level “3”.
- **ALL EVENTS:** This option will display the event log record.
- **INFORMATION:** In this menu there is system information that every user can access.
- **TEST LED:** All LED indicators are being lit simultaneously to confirm functionality (same as LAMP TEST key).

To select an option, use the “UP” and “DOWN” keys and then press “ENTER”.

2.7.1 Events menu

The option “**ALL EVENTS**” displays the event log record, similar to the figures 2-6 (Events menu) on the right. The figures are samples of an information event and of a fault event.

The first line indicates “**GENERAL**” for information events, “**FAULT**” for fault events, and “**ALARM**” for alarm events and “**PREALARM**” for prealarm events.

Information events are marked with an “i”, fault events are marked with an “x” and prealarm / alarm events are marked with a “△”.

The second line shows the source of the event.

Beneath there is a detailed description of the event, date and time. In the last row there is the current event number to the total records.

To navigate between the events, use up/down keys. Esc key returns to the previous menu.

Note: All BSR-100X control panels have the capacity of 7000 event log records. If this number is exceeded, oldest events will be deleted while new events are logged.

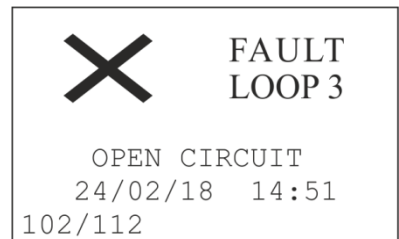
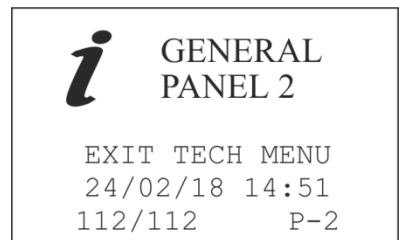

Figures2-6.Events menu

2.7.2 Test LED

By selecting “**TEST LED**” option the screen on the right appears (with not any data showing). At the same time, all LED indicators are being lit simultaneously for 5 seconds, in order to check functionality.

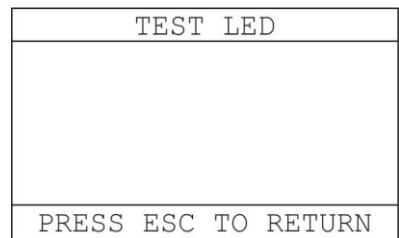

Figure2-7.Test LED

2.7.3 Information

By selecting “**INFORMATION**” the menu displays the available options on the first screen below. There are additional options following that will appear by scrolling down the menu with down key, as shown in the following screens.

INFORMATION	INFORMATION	INFORMATION
PANEL POWER SUPPLY ▲	PANEL RELAYS ▲	TECHNICIAN INFO ▲
ALARMS COUNTER	EXTRA RELAYS	ANNUAL CHECK DATE
TESTS	CONVENTIONAL SIRENS	PANEL SOFT VERSION
ZONES	TASKS	
POINTS	NETWORK PANELS	
LOOPS ▼	ETHERNET ADAPTOR ▼	

Figures2-8.Information menu

The first option, “**PANEL POWER SUPPLY**” shows input, battery and charging voltage.

PANEL POWER SUPPLY	
MAINS	OK
VDC IN	25.0 VDC
BATTERY	26.4 VDC
CHARGER	26.7 VDC
PRESS ESC TO RETURN	

Figure2-9.Panel power supply

“**ALARM COUNTER**” option displays the total number of alarms recorded in accordance to EN 54-2

ALARMS COUNTER
26
PRESS ESC TO RETURN

Figure2-10.Alarms counter

The “**TESTS**” option displays the submenu on the right.

The first option, “**PANELS IN TEST**” displays the control panels within a panel network, which are in test mode.

The second option, “**ZONES IN TEST**” displays if the 128 zones of the current panel are on test or not (all zones in test or no zones in test).

TESTS
PANELS IN TEST
ZONES IN TEST

Figure2-11.Tests

The “**ZONES**” option displays the submenu on the right.

ZONES
ZONES IN ALARM
ZONES IN FAULT
DISABLED ZONES
ZONESIN TEST
ALARMS IN TEST ZONES

Figure2-12.Zones

The “**ZONES IN ALARM**” option will display all zones that are in alarm state. If no zone is in alarm, the screen on the right will be displayed.

The “**ZONES IN FAULT**” option will display the zones that are in fault. If no zones are in fault the screen on the right will be displayed.

The “**DISABLED ZONES**” menu will display the disabled zones. If no zones are disabled the screen on the right will be displayed.

The “**ZONES IN TEST**” option will display the message “**ALL ZONES IN TEST**” or “**NO ZONES IN TEST**”, according to the current setting.

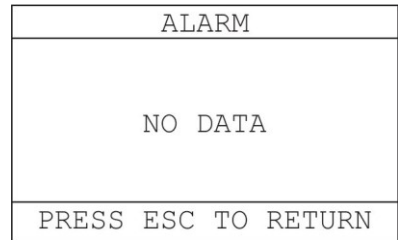

Figure2-13.Zones in alarm

The “**ALARMS IN TEST ZONES**” option displays the zones that are set in test mode and are also in alarm state. This option is meant to be used during maintenance.

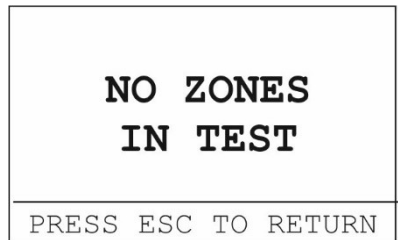

Figure2-14.Zones in test

By selecting the “**POINTS**” option in the information menu, the control panel first prompts for selecting loop of the point.

Use up/down keys to select the loop of the point and click Enter.

Then the control panel asks for the address of the point in the loop. Do the same.

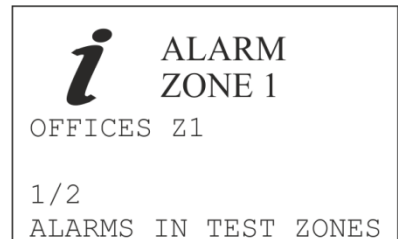

Figure2-15.Alarms in test zones

The information of a point is displayed as the screen on the right. If the selected address does not exist, the control panel displays the first point in the loop.

With up/down keys you can navigate between the points’ addresses. With left/right keys you can navigate between the loops.

By pressing **View Alarms** key, the screen alternates between 4 tabs, showing more info regarding this point, such as state, value, alarm limits, delay, etc.

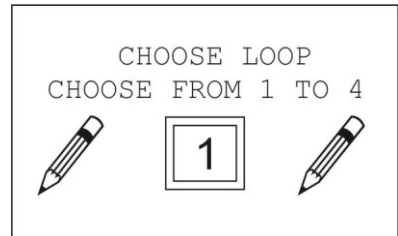

Figure2-16.Points input

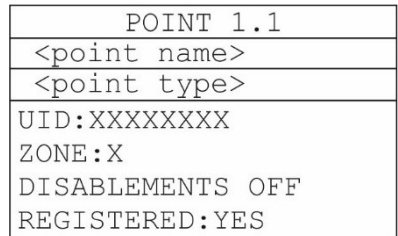

Figure2-17.Points

By selecting “**LOOPS**” option, the screen on the right appears.

The first line, “**STATUS**”, shows if the loop is present and active.

The rest of the lines, indicate how many of each point type are registered into this loop.

The last line “**POINTS:**” indicates the number of points registered in this loop to the total number of registered points.

On the screen on the right (fig2-17) an example is displayed from a control panel with 49 points in total. 21 of them are installed in loop 1.

With up/down keys, you can navigate between the loops.

LOOP: 1
STATUS : ACTIVE
DETECTORS: 12/25
SIRENS: 4/10
CALL POINTS: 4/12
IO UNITS: 1/2
POINTS: 21/49

Figure2-18.Loops

By selecting “**PANEL RELAYS**” option, the screen on the right appears.

The first line defines the name of the selected relay and the second line indicates the event that triggers the relay.

The “**LOGIC**” shows the operating mode (positive/negative), which defines the initial position of the relay contacts. The “**DELAY**” shows the selected delay for the specific relay that is applied before arming. Last, “**SILENCE**” shows if this relay will switch to initial position when “**SIREN SILENCE**” command is given.

Please note that RELAY 1 (FAULT) and RELAY 2 (ALARM) are not editable by user. Only RELAY 3 (AUX) is editable in terms of functionality mode, initial state (logic), delay and silence.

Navigate between the panel relays with up/down keys.

RELAY: 1
NAME: FAULT
ON FAULT
LOGIC: NEGATIVE
DELAY: 0
SILENCE: NO

Figure2-19.Panel relays

By selecting “**EXTRA RELAYS**” option, the screen on the right appears.

The first line indicates the event that triggers the relay (functionality mode).

The “**LOGIC:**” shows the state (positive/negative), which defines the initial position of the relay contacts. The “**DELAY:**” shows the selected delay for the specific relay that is applied before arming. Last, “**SILENCE:**” shows if this relay will switch to initial position when “**SIREN SILENCE**” command is given.

Navigate between the extra relays with up/down keys.

RELAY: 1
ON ALARM
LOGIC: POSITIVE
DELAY: 0
SILENCE: NO

Figure2-20.Extra relays

IMPORTANT! Extra relays (BS-615) belong to peripheral equipment and are not pre-installed in the control panel.

By selecting “**CONVENTIONAL SIRENS**” option, the screen on the right appears.

The first line indicates the event that triggers the siren (functionality mode). The “**DELAY**” shows the selected delay for the specific siren that is applied before sounding. Last, “**SILENCE**” shows if this siren will be muted when “**SIREN SILENCE**” command is given.

Navigate between the conventional sirens with up/down keys.

SIREN: 1
ON ALARM
ACTIVATED
DELAY: 0
SILENCE: YES

By selecting “**TASKS**” option, the screen on the right appears.

The first line shows the name of the task (editable via pc software). The second line shows the function logic (AND / OR) of the task. “**ZONES NUMBER**” shows the total number of zones that have been selected to trigger this task.

Navigate between the tasks with up/down keys. If no tasks have been set the screen will display a “**NO DATA**” message.

Figure2-21. Conventional sirens

TASK 01
NAME: CORRIDORS EV. LOGIC: AND
ZONES NUMBER: 2
PRESS ESC TO RETURN

Figure2-22. Tasks

NETWORK PANELS
ACTIVE ADDRESSES PANELS IN TEST NAME

Figure2-23. Network panels

By selecting “**NETWORK PANELS**” option, the screen on the right appears.

The available options are valuable only for panel networks. The first option “**ACTIVE ADDRESSES**” shows the detected panels in network and is only available to the Master control panel.

The second option “**PANELS IN TEST**” shows which of the connected panels in the network are in test mode.

The third option “**NAME**” will display the name of the panel (editable via PC software or web interface), the network address of the panel and its serial number.

ETHERNET ADAPTOR
ETHERNET PCB : YES
IP = 010.000.001.105
MAC 54:55:30:23:03:16
PRESS ESC TO RETURN

Figure2-24. Ethernet adaptor

By selecting “**ETHERNET ADAPTOR**” option, the screen on the right appears. When “**ETHERNET PCB**” is active, the value will be YES, else is NO. When the Ethernet adaptor is activated, the IP Address (IPv4) of the control panel will be displayed, as well as the MAC Address of it.

By selecting “**TECHNICIAN INFO**” option, the screen on the right appears.

The OLYMPIA ELECTRONICS S.A. contact info is displayed by default.

This information can be changed via PC software or web interface by the installer, in order to provide the desired company’s name and telephone number.

This information must match to the contact that is responsible for maintenance and repairs of the fire detection system.

TECHNICIAN INFO
OLYMPIA ELECTRONICS 00302353051200 BUILDING
PRESS ESC TO RETURN

Figure2-25. Technician info

By selecting “**ANNUAL CHECK DATE**” option, the next scheduled maintenance date is displayed. In order for the date to be displayed, the installer must enable annual check warning through technician menu, else “**INACTIVE**” message is displayed.

ANNUAL CHECK DATE
25/02/20
PRESS ESC TO RETURN

Figure2-26. Annual check date

By selecting “**PANEL SOFT VERSION**” option, the screen on the right appears, displaying the firmware installed on the panel, for the CPU and the loop circuits. The last line also displays the panel’s serial number.

Note! On the screen it is only displayed the firmware for the installed loops.

e.g. On the right, the screen depicts that 4 LOOPS have been installed to the panel. Accordingly, if only one LOOP has been installed, the lines LOOP 2, LOOP 3. LOOP 4 would be empty.

BSR-100x	
VER. 4.03 R	
LOOP 1	VER. 3.00
LOOP 2	VER. 3.00
LOOP 3	VER. 3.00
LOOP 4	VER. 3.00
PANEL SN : 1016	

Figure2-27.Panel software version

3 User's Menu

This chapter contains information for user access with access level 2 (code protected).

Press Enter key once to enter main menu. User menu option appears on the monitor (figure 4-1).

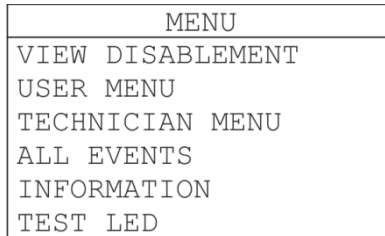

Figure3-1.Main Menu

Then select **“USER MENU”** and click Enter.

A code is required for level 2 access. Therefore, only authorized users will be able to do any adjustments at this level.

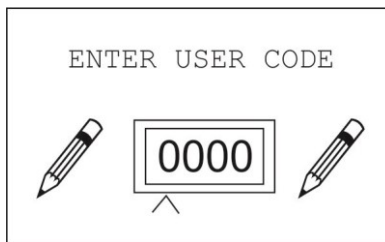

Figure3-2.User code input

To type the code, use the up/down keys to adjust each digit and right or left to move between digits. When the code is typed, press Enter.

The factory default code is **“1000”**.

The following figure shows the user's menu diagram:

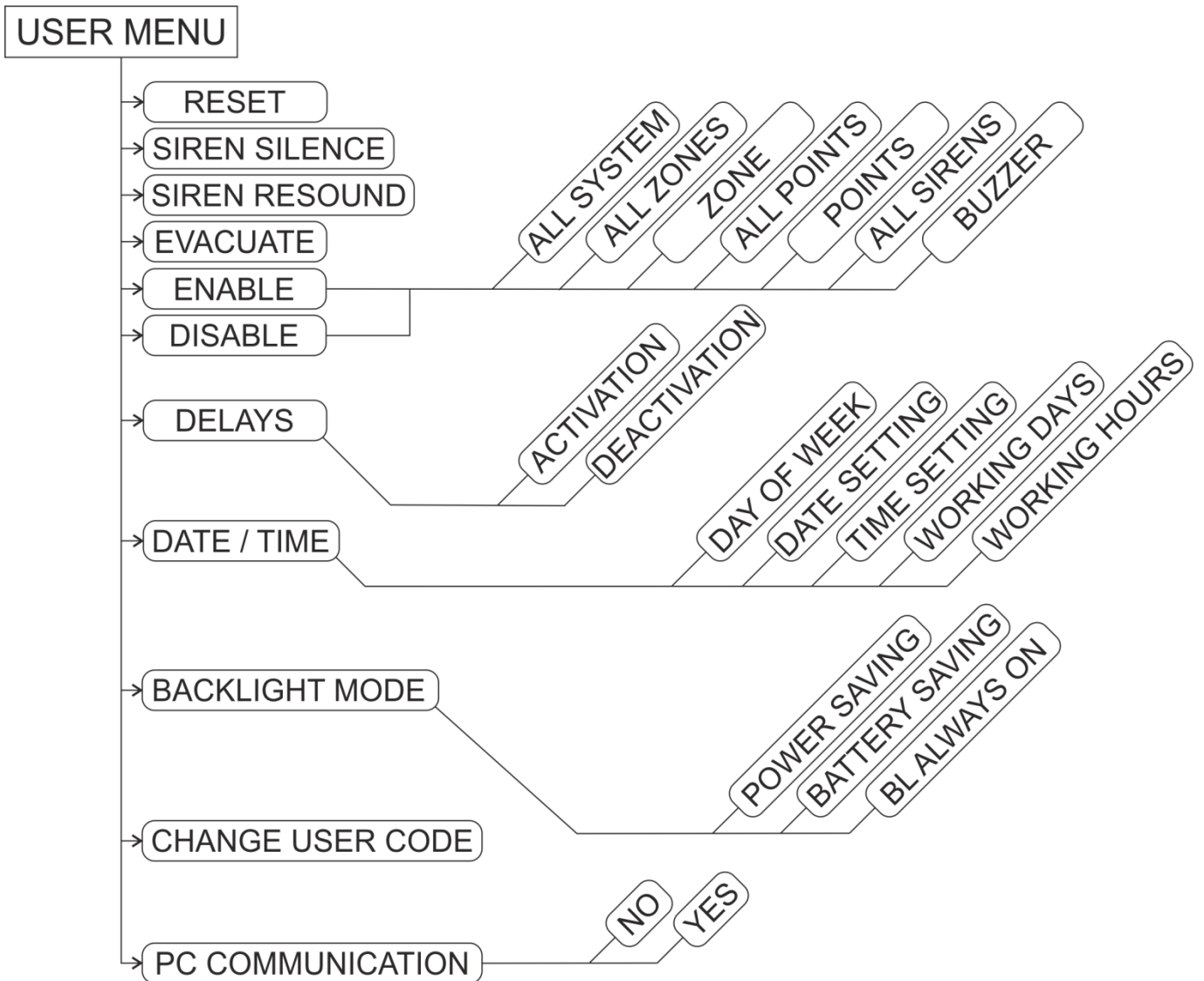

Figure 3-3. User's menu diagram

In this menu, the following basic functions can be done

- **RESET** the system (clears current alarms, prealarms and faults)
- **SIREN SILENCE** in case of an alarm event, to mute audible alarm.
- **SIREN RESOUND** to restore audible alarm after silencing.
- **EVACUATE** to manually trigger alarm state (for evacuation).

3.1 Enable / Disable segments

Via the "ENABLE" and "DISABLE" options, the user can enable or disable any segment of the control panel, as shown in figures 3-4. By disabling a segment, all faults and alarm signals received by that segment will be ignored by the control panel. By enabling it, the monitoring of this segment is restored.

The available options for enable / disable are the same:

- **TOTAL:** all segments of the control panel
- **ALL ZONES:** all zones at once
- **ZONES:** single zone, the panel asks to choose zone
- **ALL POINTS:** all loop devices – points (except sirens)
- **POINTS:** single loop device - point (except sirens), the panel asks for loop and address of the point
- **ALL SIRENS:** all conventional and addressable sirens
- **BUZZER:** control panel notification built-in buzzer

The option "ZONES" asks the user to select the zone to enable or disable. Use up/down keys to type the zone number and press Enter to select.

The option "POINTS" first asks the user to input the loop in which the point is installed. Use up/down keys to type the loop number and press Enter to select.

Next, input the address of the point to enable or disable. Use up/down keys to type the address and press Enter to select.

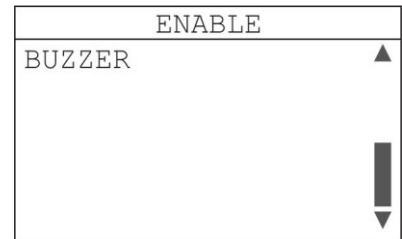
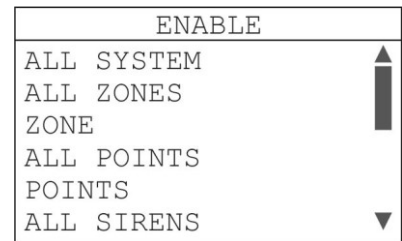

Figures3-4.Enable Menu

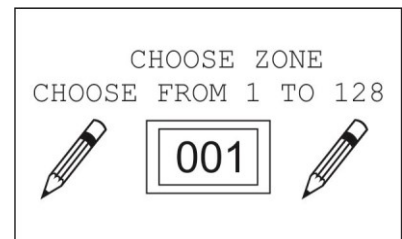

Figure3-5.Choose zone

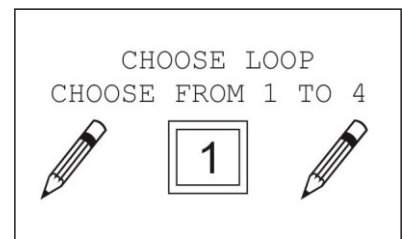

Figure3-6.Choose loop

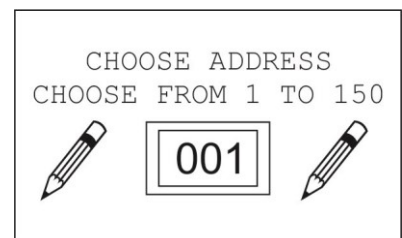

Figure3-7.Choose address

3.2 Delays Menu

Via “**DELAYS**” option the user can activate or deactivate time delays in general.

If a delay has been applied to at least one segment of the control panel, then **DELAYS ON** indicator will light yellow. By activating the delays, this setting will be applied permanently.

IMPORTANT! By deactivating the delays via this option, the deactivation will take place only for the next alarm event. Resetting the control panel will set the delays as activated again.

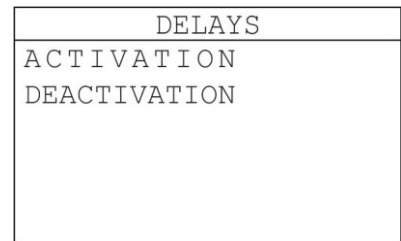

Figure3-8.Delays

3.3 Set Date / Time

Via “**DATE / TIME**” option the user can do the following settings:

- **DAY OF WEEK SETTING:** set the weekday
- **DATE SETTING:** set the date
- **TIME SETTING:** set time
- **WORKING DAYS:** set the DAY mode days (select day with up/down keys and enable/disable with right key, then enter to save setting) – Monday to Friday by default
- **WORKING HOURS:** set the working hours (from – to) – 06:00 to 16:00 by default

The settings above are crucial and need to be set precisely during installation. Automated processes and event logging rely on time and date to function properly.

By selecting “**DAY OF WEEK SETTING**” the screen on the right is shown. Use up/down keys to select the weekday and press Enter to save.

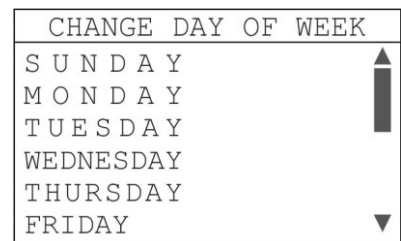

Figure3-9.Change day of week

By selecting “**DATE SETTING**” the screen on the right is shown. Use up/down keys to change digit number and left/right keys to switch between the digits, then press Enter to save.

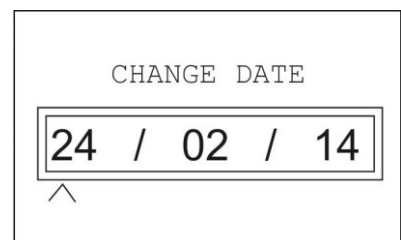
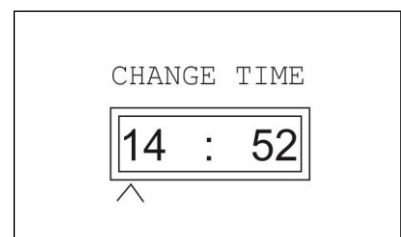

Figure3-10.Change date

By selecting “**TIME SETTING**” the screen on the right is shown. Use up/down keys to change digit number and left/right keys to switch between the digits, then press Enter to save.



By selecting “**WORKING DAYS**” the screen on the right is shown. Use up/down keys to select day and click right key to enable or disable this day. Filled box equals to enable. When set press Enter to save.

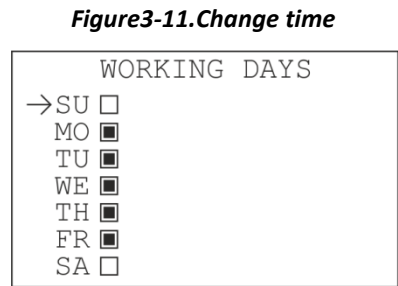

Figure3-11.Change time

By selecting “**WORKING HOURS**” the screen on the right is shown. First you need to set the working start time. Use up/down keys to change digit number and left/right keys to switch between the digits, then press Enter to save.

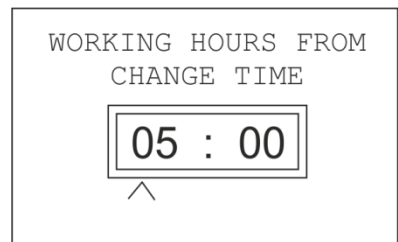

Figure3-12.Working days

Then do the same for the end time.

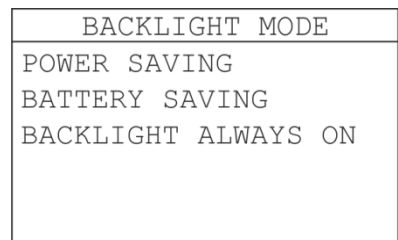

Figure3-13.Working hours

3.4 Backlight mode

By selecting “**BACKLIGHT MODE**” the submenu on the right is shown.

The first option, “**POWER SAVING**” will turn off backlight at any state, after 1 minute of inactivity. The second option, “**BATTERY SAVING**” will only turn off backlight while on battery power (mains interruption), after 1 minute of inactivity. Last, the option “**BACKLIGHT ALWAYS ON**” will keep the backlight always on.

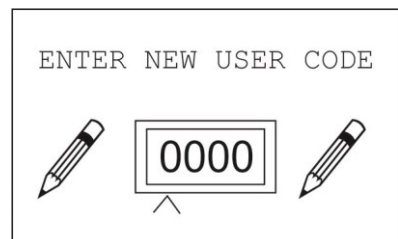

Figure3-14.Working hours

3.5 Change user’s code

Via this option the user can change the code for level 2 access. By selecting this option the screen on the right appears. To type the code, use the up/down keys to adjust each digit and right or left to move between digits. When the new code is typed press Enter to save. You will need to enter code again for confirmation. The new code replaces the previous.

WARNING: Changing the user’s code is an action that must be taken responsibly. If the user’s code is lost, the only way to restore the code is by accessing with technician code (level 3 access only).

3.6 PC Communication

The “**PC COMMUNICATION**” option is used to download panel’s data to a PC via USB cable, running the BSR-100X software application.

This function may seem useful, in order to keep event logs, keep a record of current configuration as a backup or to gather and send useful data to manufacturer in terms of troubleshooting.

When selected, a confirmation message as the screen on the right will be displayed. When the PC communication starts, the control panel will be awaiting for a request from the PC. With level 2 access code, the user can only receive data from the panel to PC (current configuration and event log).

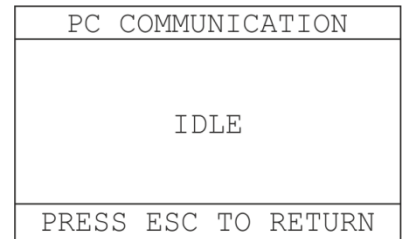
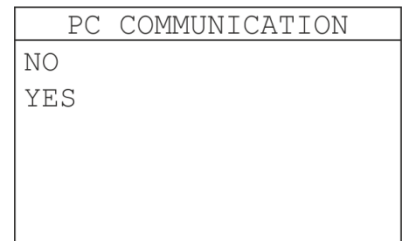

Figures3-16.PC Communication

3.7 Operating via PC (Ethernet)

This chapter contains information on how to monitor and configure the panel remotely via a common web browser (web interface), on a Local Area Network (Ethernet connection required).

3.7.1 Control panel web interface

To operate the panel via PC (web interface) no special software is required. A common web browser (Chrome, Firefox, Internet Explorer etc.) can be used. The following instructions have been made using Mozilla Firefox.

The requirements to operate the panel remotely are the following:

The panel must have an Ethernet adaptor installed, the IP address of the panel must be known, the computer must be connected to the same local network and the computer's network settings must be properly adjusted. All the settings must be done by the building's network administrator.

Open a web browser and type the panel's IP address to the URL box (e.g. 10.0.9.105). If the connections have been done properly the following page will appear.

Please note that you need to do the proper settings via technician menu to set Ethernet adaptor as enabled and set the IP address of the panel before accessing via web browser.

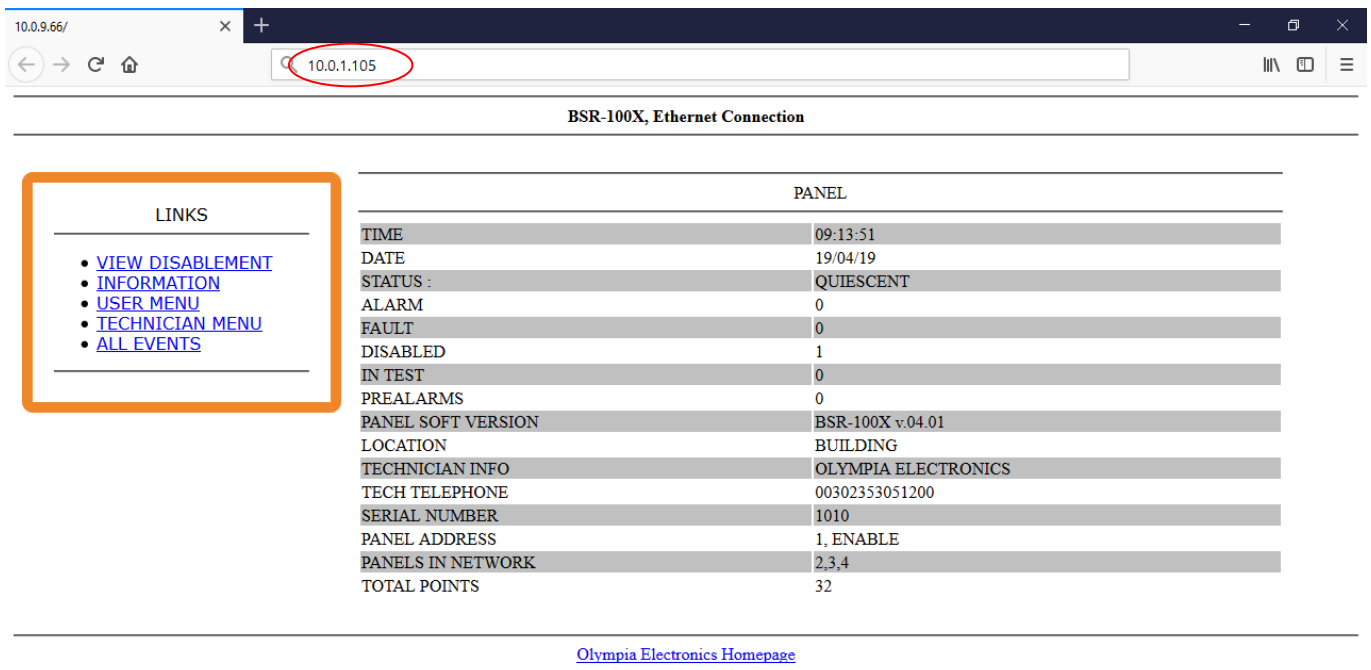

On the right section are appearing the system's general information and its status condition.

On the left section with the title LINKS, all available options are appearing for the user with access level 2. The technician menu is only accessible with level 3 access code.

3.7.2 View current alarms, faults and prealarms

If any of the events above are present to the system, the link to view alarms, faults or prealarms will be available as first option; else these options will not be displayed.

CURRENTS ALARMS
001, ALARM, POINT 1.013, POINT 1.013 FIRE, P-1,Z-1

3.7.3 View disablement

If there are any disabled segments on the system, by clicking on this link, all disabled segments will be displayed in separate lines.

3.7.4 Information

The “**INFORMATION**” link will lead to a submenu with multiple available informational options. These options are described below:

3.7.4.1 Information Panel

This option will display the page below, with the most significant data of the control panel (hardware based).

INFORMATION	
TIME	09:50:27
DATE	03/04/19
MAINS VOLTAGE :	OK
VIN	24.2 V
CHARGER VOLTAGE :	26.5 VDC
BATTERY VOLTAGE :	26.6 VDC
ALARMS COUNTER	0
IP	010.000.001.105
MAC	54:55:60:11:03:F2 (HEX), 084:085:096:017:003:242 (DEC)
PANEL SOFT VERSION	BSR-100X v.03.41-MU
LOOP 1 VER.	1.54
LOOP 2 VER.	1.54
LOOP 3 VER.	1.54
LOOP 4 VER.	--

[\[INFORMATION\]](#)

3.7.4.2 Information Zones

This option will display a series of 32 pages with 4 zones per page (all 128 zones in total). On each line entry, the number, name, disablement status, functional status, test mode and test status are shown:

ZONES					
ZONES	NAME	DISABLED	STATUS :	TEST	TEST STATUS :
1	ZONE 1	NO	NORMAL	NO	-
2	ZONE 2	NO	NORMAL	NO	-
3	ZONE 3	NO	NORMAL	NO	-
4	ZONE 4	NO	NORMAL	NO	-

« 1 2 3 4 5 ... 32 »

[\[INFORMATION\]](#)

3.7.4.3 Information Ethernet adaptor

This option will display Ethernet adaptor IP and MAC address.

INFORMATION ETHERNET ADAPTOR	
IP	010.000.001.105
MAC	54:55:60:11:03:F2 (HEX), 084:085:096:017:003:242 (Decimal)

[\[INFORMATION\]](#)

3.7.4.4 Information Loops

This option will display loop information, regarding the connected point types to each one of them.

LOOPS						
LOOPS	STATUS :	DETECTORS	SIRENS	CALL POINTS	IO UNITS	POINTS
1	ACTIVE	15/17	2/4	5/6	2/2	24/29
2	ACTIVE	2/17	1/4	1/6	0/2	4/29
3	ACTIVE	0/17	1/4	0/6	0/2	1/29
4	ACTIVE	0/17	0/4	0/6	0/2	0/29

[\[INFORMATION\]](#)

3.7.4.5 Information Points

This option will open the page below. On the input boxes you can enter the point's loop and address. By clicking "OK" the information of the selected point will be displayed on the field below.

POINTS	
CHOOSE LOOP (1-4):	<input type="text" value="1"/>
CHOOSE POINT (1-150):	<input type="text" value="1"/>
<input type="button" value="OK"/>	

NAME	POINT TYPE	UID	ZONE	DISABLEMENT	REGISTERED	CURRENT VALUE	ALARM	PREALARM
POINT 1.001	OPTICAL SMOKE-HEAT	00003321	1	NO	YES	10	NO	NO
FAULT	ALARM LIMIT	PREALARM LIMIT	NIGHT LIMIT	MODE	ZONE/TASK	DELAY	SILENCE	
NO	100	0	100	ON ALARM	-	0 MIN	NO	

[\[INFORMATION\]](#)

3.7.4.6 Information Panel Relays

This option will display the settings of the panel's on-board relay outputs. Please note that only AUX relay can be edited (by technician).

RELAYS						
RELAY	NAME	MODE	ZONE/TASK	LOGIC	DELAY	SILENCE
1	FAULT	FAULT	-	NEGATIVE	0 MIN	NO
2	ALARM	ALARM	-	POSITIVE	0 MIN	NO
3	AUX	ALARM	-	POSITIVE	0 MIN	YES

[\[INFORMATION\]](#)

3.7.4.7 Information Extra Relays

Same as panel relays, the extra relays option contains similar information for the extra relays settings.

RELAYS

RELAY	MODE	ZONE/TASK	LOGIC	DELAY	SILENCE
1	ON ALARM	-	POSITIVE	0 MIN	NO
2	ON ALARM	-	POSITIVE	0 MIN	NO
3	ON ALARM	-	POSITIVE	0 MIN	NO
4	ON ALARM	-	POSITIVE	0 MIN	NO

RELAY	MODE	ZONE/TASK	LOGIC	DELAY	SILENCE
5	ON ALARM	-	POSITIVE	0 MIN	NO
6	ON ALARM	-	POSITIVE	0 MIN	NO
7	ON ALARM	-	POSITIVE	0 MIN	NO
8	ON ALARM	-	POSITIVE	0 MIN	NO

[\[INFORMATION\]](#)

Extra relays belong to peripheral equipment and are not pre-installed in the control panel.

3.7.4.8 Information Conventional Sirens

This page displays all settings for the conventional sirens.

CONVENTIONAL SIRENS

SIREN	MODE	ZONE/TASK	STATUS :	DELAY	SILENCE
1	ALARM	-	ENABLE	0 MIN	YES
2	ALARM	-	ENABLE	0 MIN	YES
3	ALARM	-	ENABLE	0 MIN	YES
4	ALARM	-	ENABLE	1 MIN	YES

[\[INFORMATION\]](#)

3.7.4.9 Information Task

This page displays all tasks, their name, logic and the selected zones number. There are 50 available tasks. Click to next pages to view more tasks.

TASK

TASK	NAME	LOGIC	DELAY	ZONES NUMBER
1	CORRIDOR FIRE	AND	0 MIN	2
2	OFFICE FIRE	OR	0 MIN	3
3	ALL EVAC	AND	0 MIN	8
4	WH ALARM	OR	0 MIN	2

« [1](#) 2 3 4 5 ... 13 »

[\[INFORMATION\]](#)

3.7.5 All events

All panel's events are appearing in chronological order.

BSR-100X, ALL EVENTS

```

1233 28/03/19 13:59, GENERAL, PANEL 1, EXIT USER MENU, P-1
1234 28/03/19 14:00, GENERAL, PANEL 1, ENTER USER MENU, P-1
1235 28/03/19 14:00, GENERAL, PANEL 1, EXIT USER MENU, P-1
1236 28/03/19 14:02, ALARM, POINT 1.013, POINT 1.013 , VALUE 120, P-1, Z-1
1237 28/03/19 14:03, GENERAL, PANEL 1, RESET BY USER, P-1
1238 28/03/19 14:03, GENERAL, PANEL 1, RESET, P-1
1239 28/03/19 14:03, GENERAL, PANEL 3, RESET, P-3
1240 28/03/19 14:03, GENERAL, PANEL 2, RESET, P-2

```

« 152 153 154 **155** 156 157

[\[MAIN PAGE\]](#)

Due to the high capacity of recorded events (7k), the events are divided into pages.

3.7.6 User's menu

By selecting "USER MENU" the systems asks for user code (access level 2):

USER MENU

ENTER USER CODE

ENTER USER CODE:

Enter the user's code and click "SEND". If the code is correct, the screen below will be displayed:

USER MENU

- [RESET](#)
- [SIREN SILENCE](#)
- [SIREN RESOUND](#)
- [EVACUATE](#)

- [ENABLE ZONE](#)
- [DISABLE ZONE](#)
- [ENABLE ALL SIRENS](#)
- [DISABLE ALL SIRENS](#)

- [ENABLE ALL SYSTEM](#)
- [DISABLE ALL SYSTEM](#)
- [ENABLE BUZZER](#)
- [DISABLE BUZZER](#)
- [ENABLE POINTS](#)
- [DISABLE POINTS](#)

- [DELAYS](#)
- [DATE SETTING & TIME SETTING](#)

[\[MAIN PAGE\]](#)

All settings above and their effect have already been mentioned in **chapter 3** for **User Menu**.

 olympia electronics <small>SAFETY & SECURITY SYSTEMS</small> <i>for a safer world!</i>	Date	9/6/2022
	Document number	921100400_09_005
	Page	30 of 71

4 Installation

The following chapter contains useful information for designing and calculating the installation, describing the connection between the control panel and the detection devices and sirens, as long as the connection of the relay outputs, panel network and more.

All installation technicians shall be fully informed of the following chapter prior to any installation of the BSR-100X Analogue Addressable Fire Alarm system. Complete knowledge of the system's capabilities, functionality and design is necessary to ensure proper operation of the fire detection system.

The control panel programming can be made partially via the technician menu without the use of external devices. Some settings can be made via PC with the use of a web browser but for fully accessing all of the control panel's capabilities the programming must be made via USB connection with the use of the PC software application BSR-100X. The program is free of charge and can be downloaded from the official site of Olympia Electronics S.A.

<https://www.olympia-electronics.com/en/support/software>

All the following connections must be made while the control panel is deactivated, disconnected from mains power supply and batteries.

4.1 Safety

To ensure proper use of a device all accompanying documents must be read carefully.

This product must be installed, commissioned and maintained by **trained technician personnel** in accordance with:

- The regional regulations for the installation of electrical appliances in buildings
- The regional Fire Safety regulations
- Manufacturer's instructions

-The device mains power supply is rated at 220-240V AC / 50-60Hz, being a **Class I** product (the corresponding terminal contact with the "Protective Earth" Ⓧ marking, inside the device, must be connected to the building's ground to ensure proper function and safety).

- Being a type B equipment (permanently connected to mains) the mains power supply to the device must be connected to the existing building's electrical installation, with its own separate power line and circuit-breaker rated at 16A, labeled with "**Fire Detection System - Do not switch off**".

4.2 Installation

The panel installation should be carried out only by trained technician personnel.

Prior to any installation ESD protection precautions should be taken according to ESD regulations



Prior to any maintain ace disconnect mains power and disconnect batteries.

Do not remove or insert pcbs or other components when mains power or batteries are connected.

The panel should be permanently installed.

4.3 Control panel installation

The control panel installation must be done by trained personnel exclusively. Do not touch, add or remove boards or components, perform connections or do other modifications, while mains power supply is connected. ESD protection is necessary before touching any of the control panel electronics.

4.3.1 Description of the interior of the panel

To access the control panel's interior first unlock the key-lock on the front with the key (included in package).

On the door of the panel, is located the CPU control board with the LED indications. The CPU control board may contain an Ethernet adaptor, a printer adaptor or a MODBUS adaptor at left side (optional). There is also a Dip-switch selector at the bottom right side of the board, which is used to grand access level 4 for specific functions. At the bottom left side is also located a Mini-USB port for programming the control panel via PC.

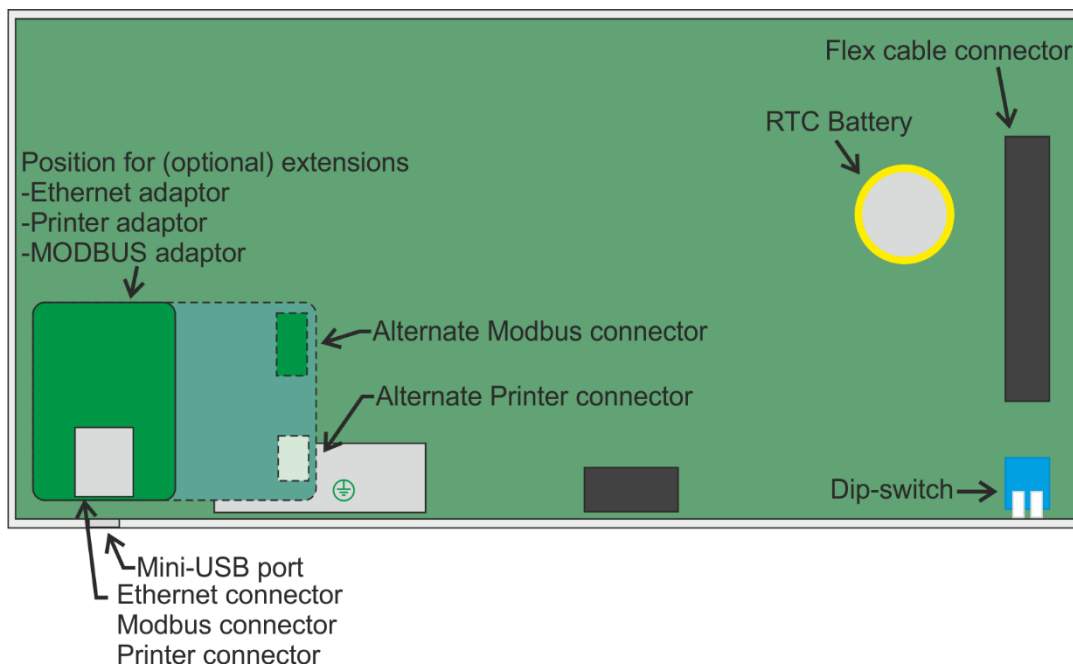

Figure4-1.CPU control board

On the main body of the metal casing are located the power supply unit (right), the input/output board (I/O) (left), the loop boards (center), the battery area (bottom), the mounting holes and the cable openings (see figure 4-2).

4.3.2 Placing the panel on wall

The selected placement area of the panel will have to be clean, dry and free of collisions and vibrations. The panel must be permanently installed on a steady position. On the following picture the interior and the mounting holes of the panel are visible. Use all 4 mounting holes for proper installation, using the included wall mounting accessories of the package.

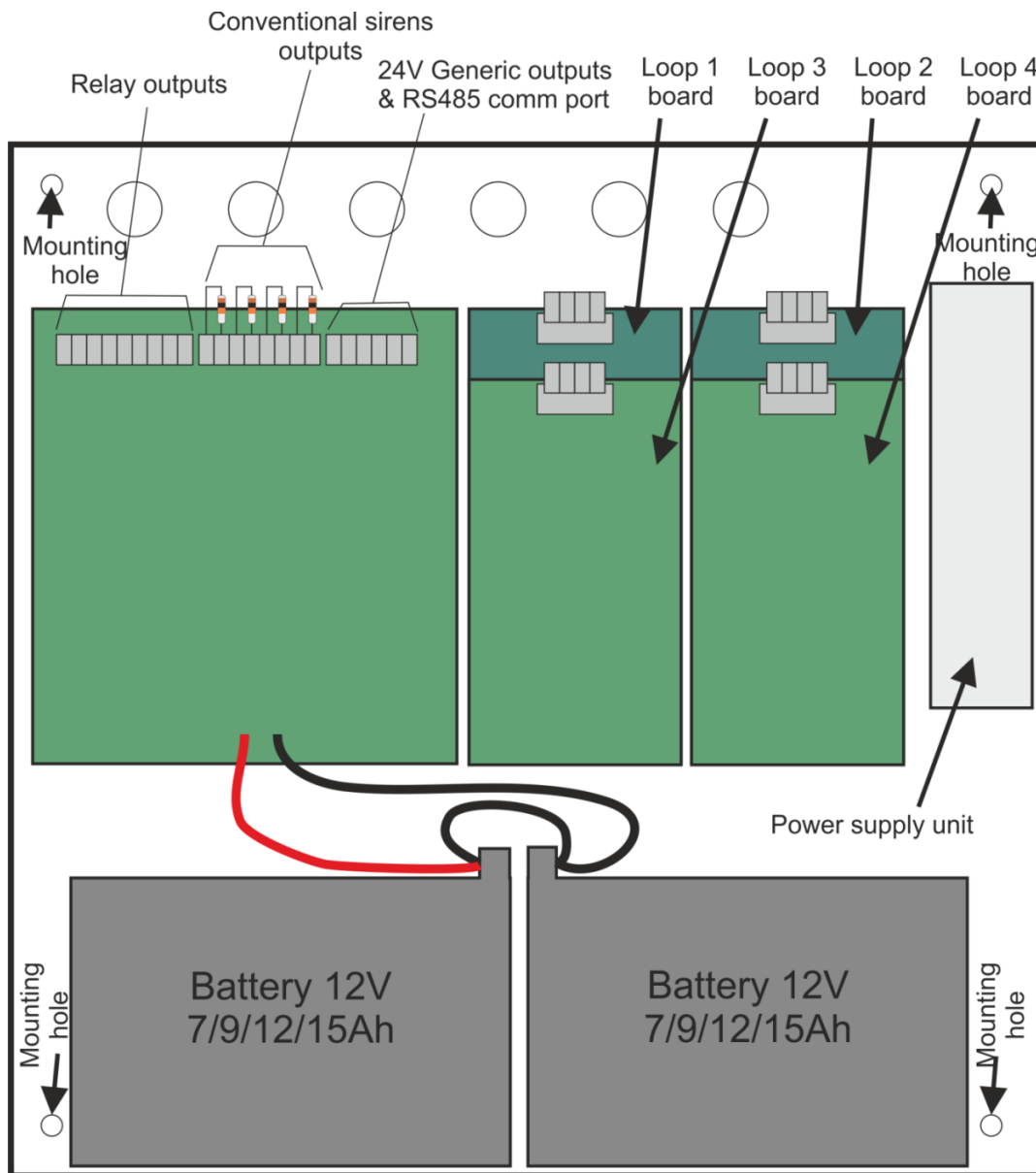

Figure4-2. Panel mountings and holes

The panel must be placed at least 1m above floor level and 1m below roof level and at the minimum distance of 30cm from other devices. No other supply lines should cross the wall behind the panel except the panels own power supply.

The control panel's placement must be to a visible and accessible area to the building attendant and fire safety personnel. This device is meant to be used indoors only.

4.3.3 Connecting the mains power supply cable (220-240V AC)

The power supply cable must be double insulated, with 3 cores, including a "ground" wire connected to the buildings ground ("Protective Earth").

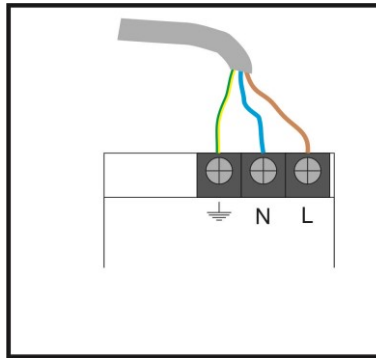

Figure 4-3. Mains power supply connection

Caution!

1. Any assignment of installation, repairs or electrical equipment maintenance must be executed with both mains power supply and batteries disconnected.
2. Connect the batteries and enable mains power supply to the control panel only after all other cable connections have been completed.
3. The mains power fuse of the panel is located in the power supply unit, rated 4A/250V (Fast), TR5 (non replaceable).
4. The battery protection fuse is self-restoring, 900mA rated soldered on the main board (non replaceable).

4.3.4 Connecting the batteries

The interior of the control panel has a space appropriate to accommodate two 12V lead-acid batteries (Pb) with the optional capacity of 7Ah, 9Ah, 12Ah or 15Ah. Both batteries must be of the same type and capacity. **Use BATTERY CALCULATOR tool included in BSR-100X software application to calculate the required battery capacity.**

The batteries must be connected in series. In the battery area there are two wires, one red and one black for connecting the batteries. The red wire must be connected to the positive pole of the first battery; the black wire must be connected to the negative pole of the second battery. An extra cable is included in the package; use it to connect the rest of the poles in between (negative pole of the first battery to the positive pole of the second battery). On the following figure 4-4, the batteries connection diagram is depicted.

In case of battery replacement, the new batteries must be of the same type and capacity. Don't mix new with old batteries. Don't discard the old batteries in common waste bins. Discard old batteries only in special bins for lead-acid battery waste, for collection and recycling.

It is recommended to disconnect mains power of the control panel while replacing the batteries for safety reasons.

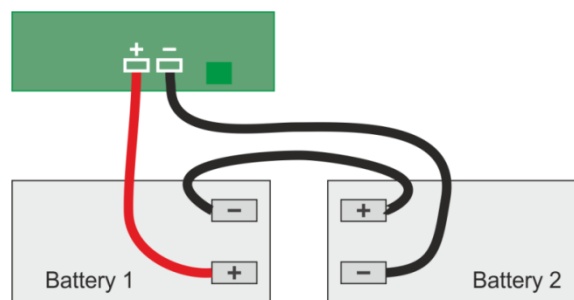

Figure4-4. Battery connection

4.4 Wiring

For compliance with the electromagnetic compatibility (EMC) requirements, the connections of the peripheral devices to the panel must be done with shielded cables.

Every cable's shield must be connected to the closest "Protective Earth" ground, to achieve the minimum electrical distance possible.

All connection wires' cross section must be between 0,7mm² (min) to 2,5mm² (max).

The maximum loop cable length should not exceed 2000m in total length.

The maximum cable resistance per loop should not exceed 50Ω when adding total point internal resistance.

IMPORTANT! Use the "**LOOP CALCULATOR**" tool Included in the BSR-100X software application for proper cable selection, prior to installation.

To the upper and back areas inside the control panel, openings are located to pass the cables through. The rubber plugs must not be removed from the openings so the ingress protection IP30 remains unchanged (EN 54-2 regulation requirement). Pierce a small hole on the plug to pass the cable trough.

Every connection must use a separate cable with a 2-core shielded cable. These connections refer to: conventional siren outputs, 24VM output, 24VP output and loop connection terminals. Don't use the same cable for multiple loops or other outputs. **The connection cables should be approved for fire detection installations.** (i.e. FP200, MICC and PYROFIL), according local requirements.

The mains power supply input cable should have 3 cores with L-N-PE color coding, rated for 230VAC (no shielding required).

The loop circuits wires and data transferring wires should be 2 cores, shielded, stranded cable. The multicore cable is not compatibly with the EN 54-14:2018

The cable cross section for connecting the conventional sirens in the sirens outputs depends on the consumption and length. The cross-sections are appearing on the following table.

Table4-1. Conventional siren cable cross-section selection (in Alarm)

Cable length (m) \ Alarm Current (mA)	200m	500m	1000m	1500m	2000m
100mA	1.0 mm ²	1.0 mm ²	2.0 mm ²	2.5 mm ²	2.5 mm ²
250mA	1.0 mm ²	1.5 mm ²	2.5 mm ²	2.5 mm ²	2.5 mm ²
300mA	1.5 mm ²	1.5 mm ²	2.5 mm ²	2.5 mm ²	2.5 mm ²

4.4.1 Loop Connections

All models of the BSR-100X family, BSR-1001, BSR-1002 and BSR-1004 share the same architecture, thus same loop connection method. They differ only on the available loop connection outputs (1, 2 or 4).

The output connections, maximum consumption and the connection diagrams that are going to be mentioned in the next paragraphs are common to all panels.

By default, all loop output connection terminals have 2 short-circuit links (+L to +LF and -L to -LF). In order to connect one or more devices to the loop output, remove the 2 short-circuit links entirely.

All loop connections are similar. A maximum number of 150 devices can be connected in each loop. Some devices may require 2 addresses to function (e.g. BSR-8120), thus the maximum number of devices is reduced respectively.

Moreover, the shields of all cables must be all connected to the “Protective Earth” in accordance with the electromagnetic compatibility (EMC) requirements. Use the ground bar terminals inside the panel to connect the cable shields.

The cable length must not exceed the limit of 2km with a maximum cross section of 2,5mm².

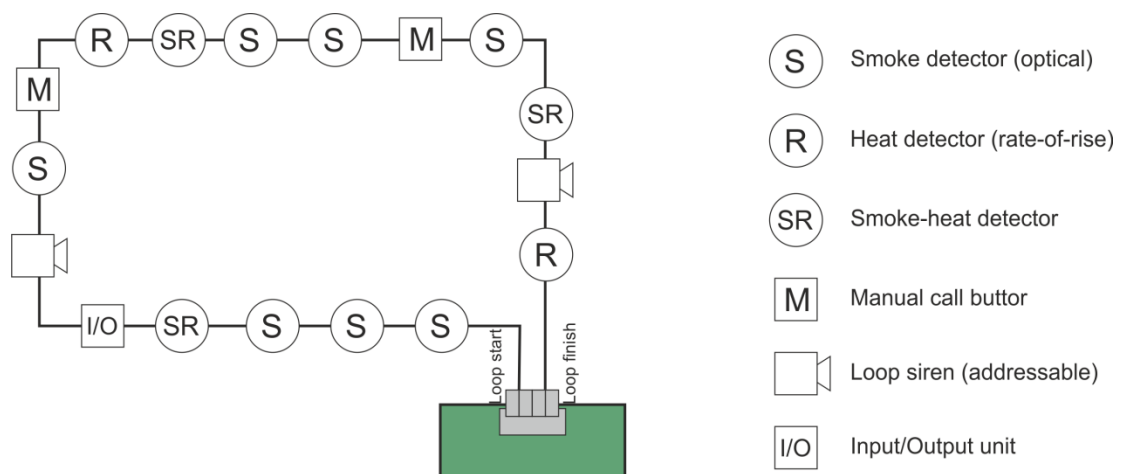

Figure 4-5. Loop diagram

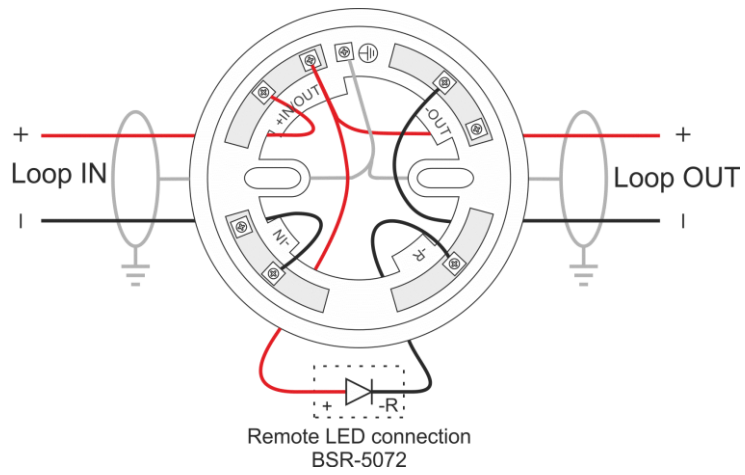

Figure 4-6. Detector base connections BSR-6155, BSR-6160 and BSR-6157

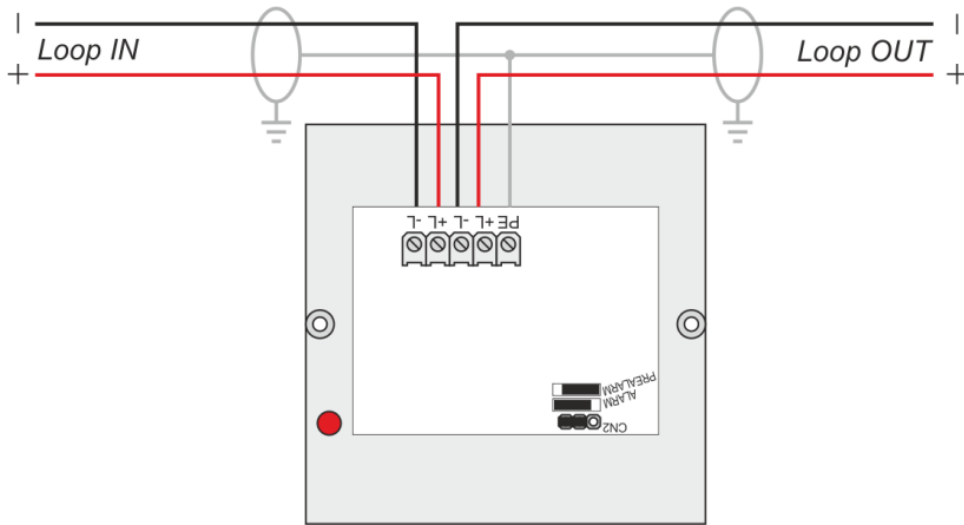

Figure 4-7. Connecting the manual call point (MCP) BSR-5136

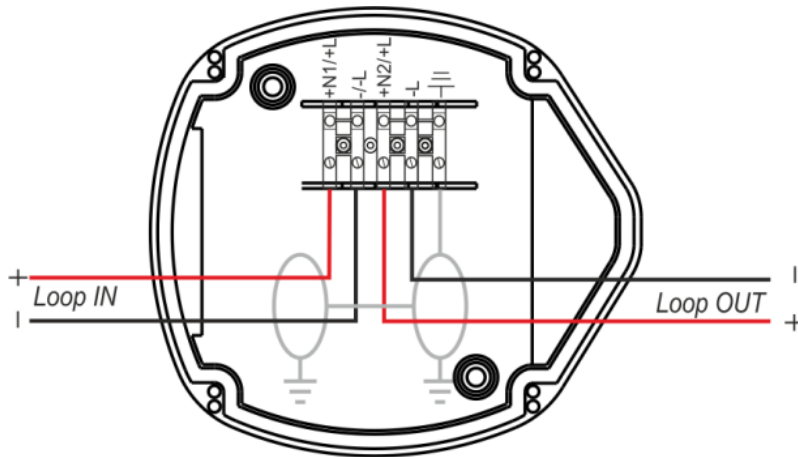

Figure 4-8. Connecting addressable siren BSR-5132

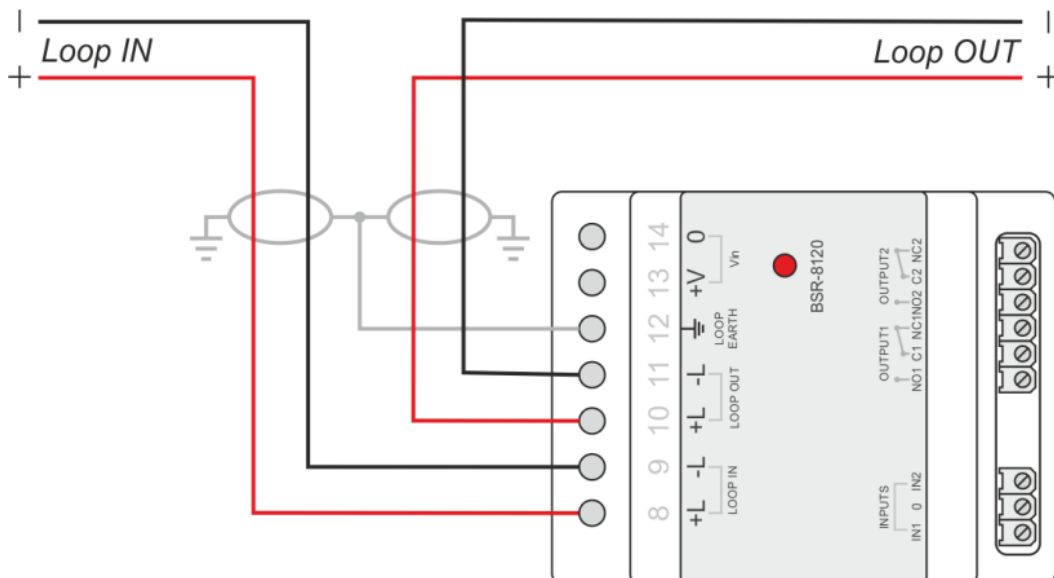

Figure 4-9. Connection of input/output unit BSR-8120

4.4.2 Connecting conventional sirens

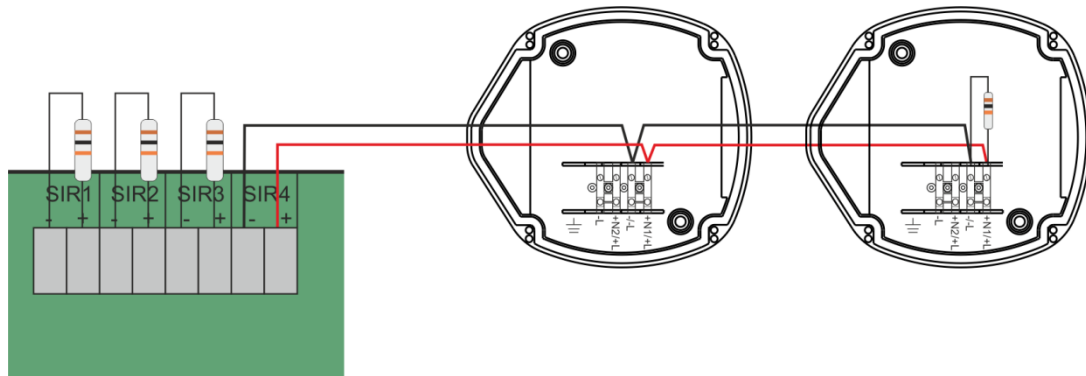

Figure4-10. Conventional sirens connection

There are four outputs to the main board for conventional sirens connection marked as «SIR1», «SIR2», «SIR3» and «SIR4». Each output can supply a current up to 300mA and it is monitored for short-circuit and open circuit. By default, 10kΩ resistors are placed on the output terminals. If the output remains unused the resistor must remain on the terminal. When sirens are connected to the output, the resistor must be removed and placed on the last siren as shown on the figure 4-10. All four circuit connections are identical.

By default all siren outputs are programmed to function simultaneously in case an alarm event occurs.

IMPORTANT! It is not permitted to disable or enable single siren outputs. All sounding alarm devices (sirens), both addressable and conventional can be enabled or disabled at once, simultaneously, via the user menu.

The conventional siren outputs can support all conventional sirens (BS-530, BS-531/1, BS-530/WP and BS-532/WP), door bells or fire alarm beacons.

4.5 Panel network connections

A network of panels can support up to 4 interconnected control panels. Each control panel owns a unique address. The master panel owns the address 1 and the subpanels have the addresses 2, 3 and 4.

The interconnection wire must be twisted pair (2-core). The connection method must be in parallel, meaning that the same wire goes along the panels without any splitting, just like in the following diagram.

The communication protocol of the panel is the RS-485. The next figure depicts the connection of a network of panels.

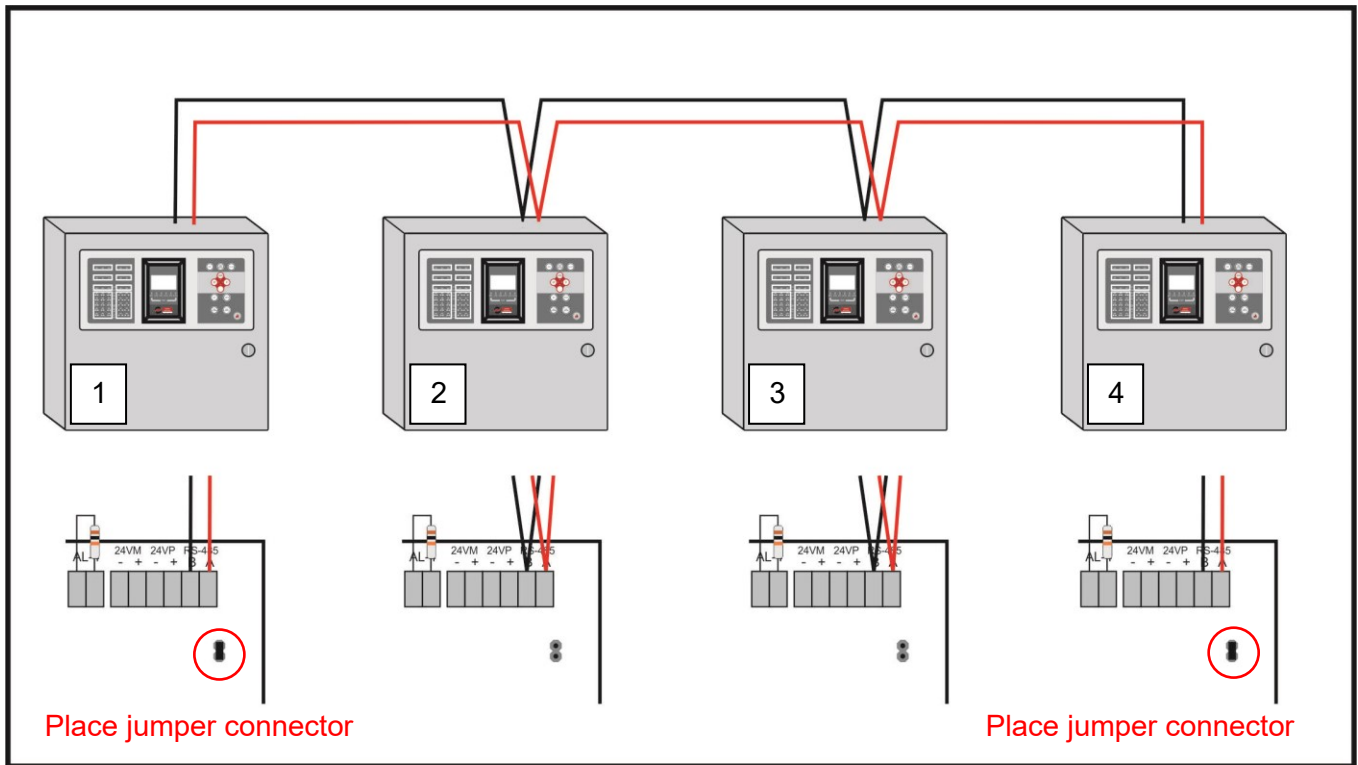

Figure4-11.Panel network connection

Be advised, the RS-485 requires 120Ω resistors on both ends. To the panels that are located on the edge of the network, a jumper connector must be placed on CN4 pin headers, under the RS485 terminal, to enable the 120Ω resistor on the board.

The cable's total length must not exceed 500m. For greater distances a RS-485 repeater must be used.

The cable's shielding must be connected on the control panel's "Protective Earth" ground.

To configure a panel network, start with setting master control panel's address first (1) and then proceed into setting the subpanels' addresses (2, 3 and 4). Then, scan the panel network via the master control panel to identify all connected subpanels.

4.6 General connections diagram

A theoretical general connections diagram is depicted below:

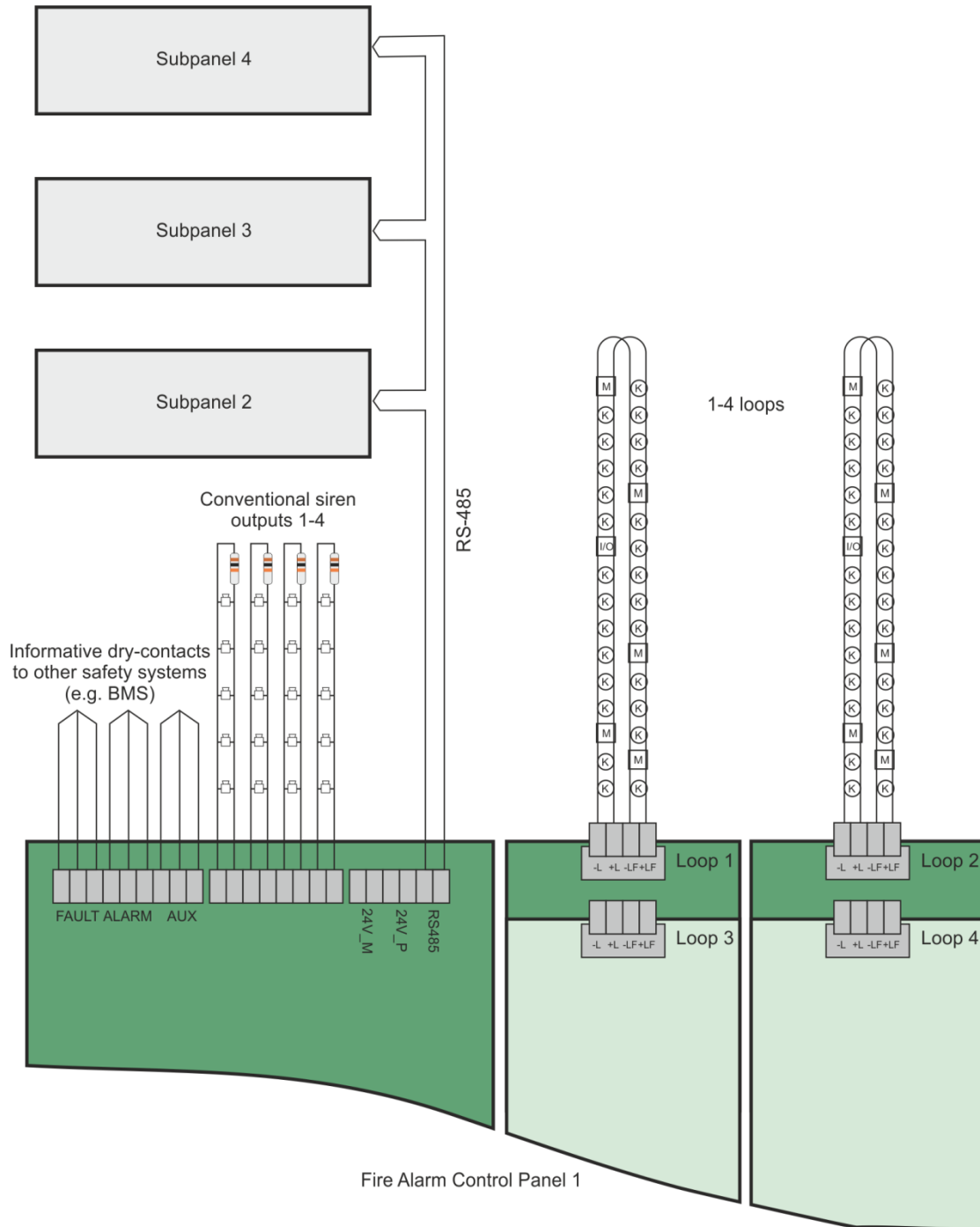

Figure4-12.General connections diagram

4.7 Other connections

The following section contains information for other available connections in the control panel.

For each of the following connection a separate cable must be used (don't use multicore cables to connect multiple outputs).

The cables' shielding must be connected to "Protective Earth" ground (it is recommended to use the metallic ground bar terminals inside the panel – top side).

On the input / output board the following outputs are available:

- **24VM:** 24V_{DC} (300mA max) generic output used for power supplying gas detectors or other devices of which the power supply must be interrupted via reset. Output is interrupted for 10" during reset.
- **24VP:** 24V_{DC} (300mA max) permanent generic output used for power supplying peripheral devices (e.g. a door's electromagnetic lock) that their input shall not be interrupted during reset.
- **ALARM Relay:** Potential free relay contacts that are triggered during an alarm event (C-NO contact circuit active when on alarm). 30V_{DC}/3A max.
- **FAULT Relay:** Potential free relay contacts that are triggered during a fault event (C-NC contact circuit active when on fault). 30V_{DC}/3A max.
- **AUX Relay:** Potential free relay contacts with a programmable output (alarm/fault/prealarm/zone/task). With selectable initial state (positive/negative logic) and optional delay. 30V_{DC}/3A max.
- **EXTRA Relays:** On middle section of the input / output board there are located 2 connection sockets for connecting extra relays (BS-615). Each connection socket controls 4 outputs and is marked with the tag "Extra Relays 1-4" or "Extra Relays 5-8". Each one of the 8 in total outputs is programmable (alarm/fault/prealarm/zone/task), with selectable logic (positive/negative) and optional delay. 30V_{DC}/3A max.

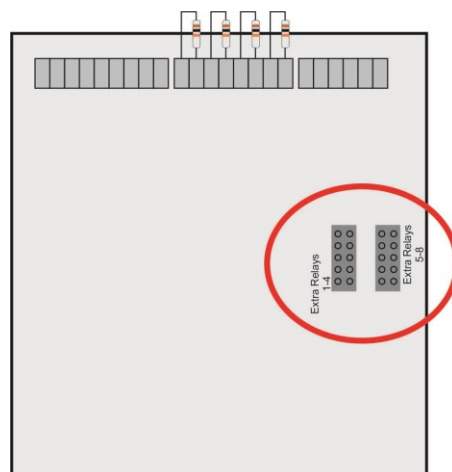

Figure4-13.Extra relay connections (for BS-615)

- **Ethernet:** To connect the control panel to a local network (Ethernet) a network cable with a RJ45 male connector must be used. An Ethernet adaptor (GR-8530) must be connected in order to provide Ethernet connectivity (optional). In order to connect the Ethernet adaptor, first deactivate the panel, by disconnected batteries and mains power and place it on the corresponding connector on the CPU board. Then power on the control panel and connect the batteries, enable the Ethernet

adaptor set up the IP address of the control panel via Technician menu and connect the network cable to the corresponding RJ45 socket on the adaptor (figure 4-14).

- **Printer:** To connect a printer adaptor, disconnect batteries and mains power and place it on the corresponding connector on the CPU board (same position of figure 4-14). Then power on the control panel and connect the batteries, go to Technician menu “**EXT. PCB FUNCTION**” and enable printer option. While the thermal printer is connected and enabled, all new events recorded will be printed on paper.
- **MODBUS:** To enable MODBUS communication between the control panel and a Building Monitoring System, a MODBUS adaptor must be installed. Disconnect batteries and mains power and place it on the corresponding connector on the CPU board (same position of figure 4-14). Then power on the control panel and connect the batteries, go to Technician menu “**EXT. PCB FUNCTION**” and MODBUS option. Select the control panel’s MODBUS address via “SELECT MODBUS ADDR.” option in Technician menu.

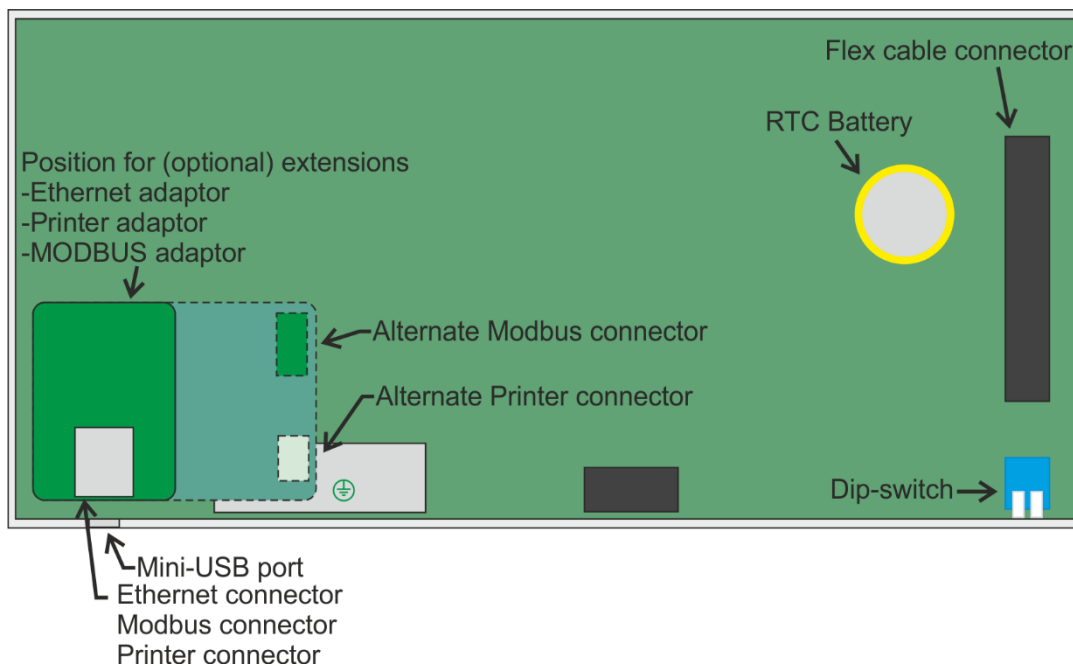

Figure4-14. Correct placement of Ethernet Adaptor, all the way to the left. (i.e., Use the first 10 pins from the left)

5 Technician Menu

The following chapter includes all information for commissioning a new installation of a **BSR-100X** Analogue Addressable Fire Alarm Panel.

The technician menu contains a set of commissioning functions, parameters and other general settings and is code protected (access level 3). Some specific functions may require access level 4 which can be granted with hardware access (dipswitch selector behind the door).

To enter Technician menu, while on home screen press Enter key once to enter main menu.

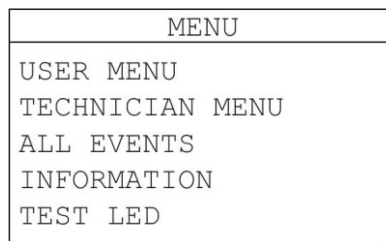

Figure5-1.Main menu

Then select «**TECHNICIAN MENU**» using up/down keys and Enter.

For accessing level 3 technician's code is asked, to prevent access to unauthorized persons to this level.

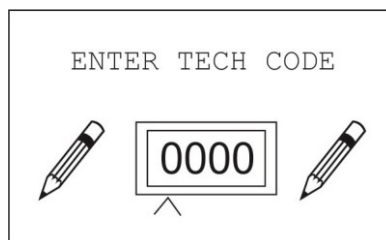

Figure5-2.Tech code input

Type the code by using up/down keys to increase digit value. Use left/right keys to go to next digit. When code is written press Enter to confirm.

The factory's default code is «**1111**».

On figure 5-3 a tree diagram of this tech menu is depicted.

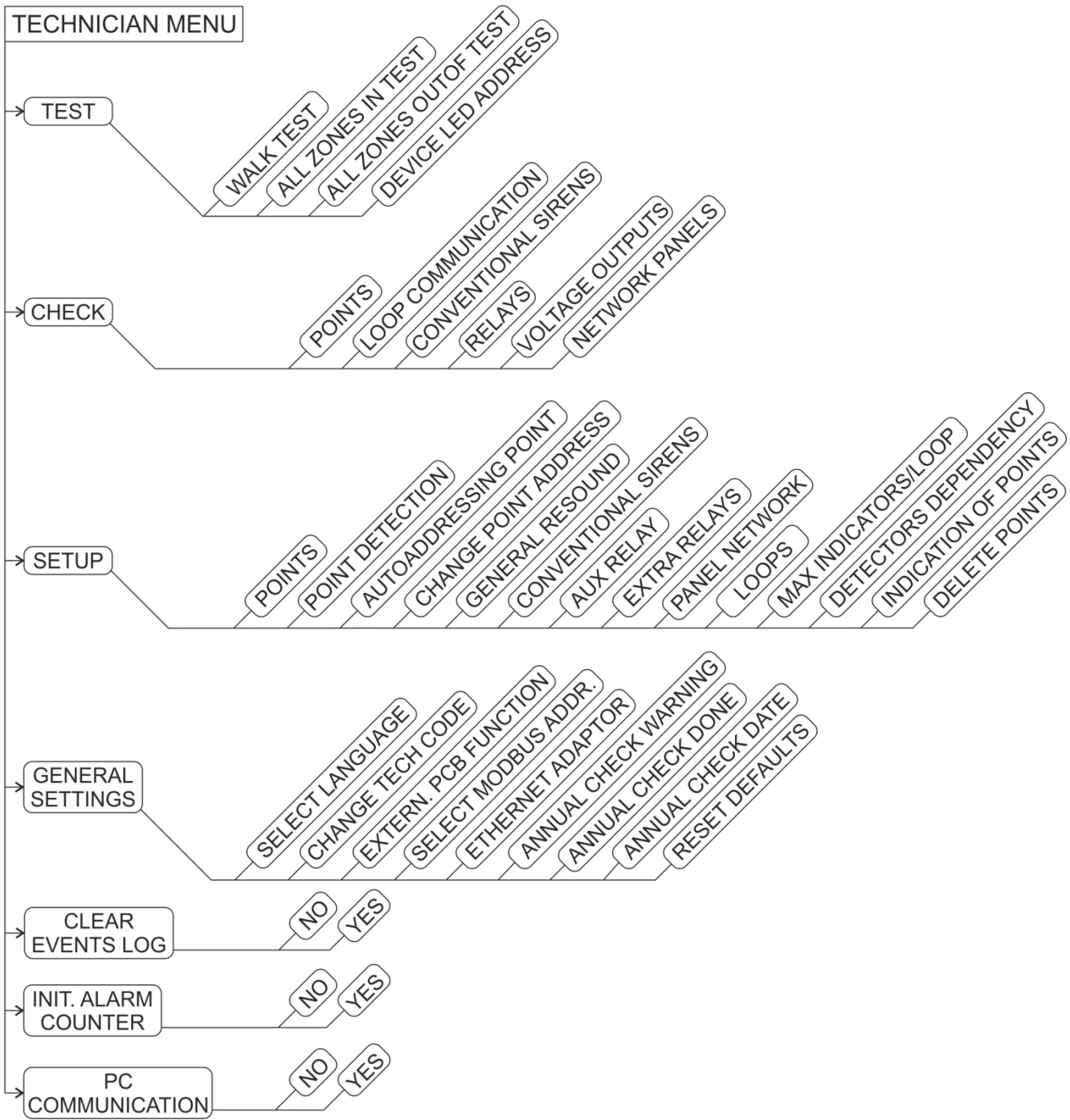

Figure5-3. Technician menu diagram

In the following sections a detailed description for every available option appears.

5.1 Test Menu

This submenu is used during periodic maintenance of the system to set the fire detection equipment in test mode in order to confirm functionality. The available options are the following on figure 5-4.

WARNING! By enabling test mode to a control panel the system's fire detection ability is inhibited until test mode is terminated. Use the following options wisely and ensure all persons present to the building are informed for scheduled maintenance of fire detection system.

5.1.1 Walk test

The first option, "WALK TEST" starts a test procedure to all connected fire detection devices connected to this control panel and lasts 1 hour (with countdown timer).

After selecting this option, the system informs the technician that during this procedure the fire detection system will not conform with EN54-2, due to temporary inactive fire detection (in test).

Next, the control panel asks for siren mode (enabled or disabled). By enabling the sirens, every time a new alarm event is triggered by any of the connected devices, all conventional and addressable sirens will sound for 6 seconds, else they stay inactive.

The walk test screen is similar to the screen on the right. Each time a new alarm is triggered, the point's name is indicated on screen for a few seconds and the point's red LED lights for 14 seconds. The panel's relay outputs are not affected by walk test, they remain to initial position.

During a walk test each fire detection device can trigger a fire alarm only one time.

Exit the walk test by pressing Esc key.

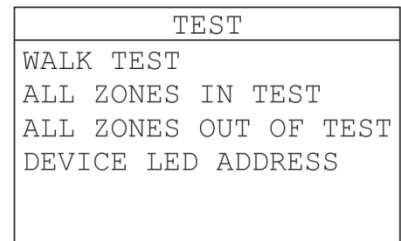
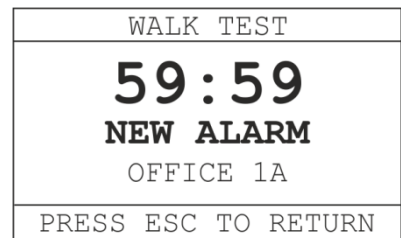
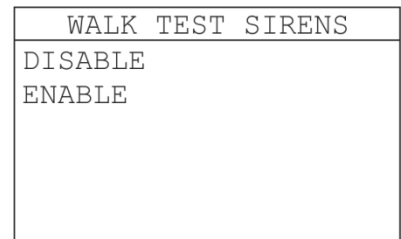
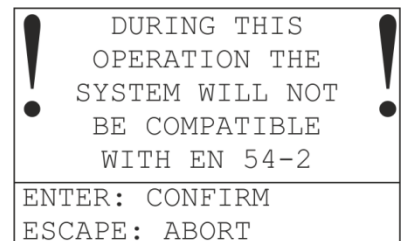

Figure5-4.Test menu



Figures5-5.Walk test

5.1.2 All zones in test

"ALL ZONES IN TEST" option instantly sets all 128 zones in test, thus all connected addressable devices in test mode. This setting is permanent, until being unset. Zones that are in alarm do not trigger a general alarm event on the control panel and are visible via: "INFORMATION > ZONES > ALARMS IN TEST ZONES".



Figure5-6.All zones in test

5.1.3 All zones out of test

"ALL ZONES OUT OF TEST" option instantly sets all 128 zones out of test.

5.1.4 Device LED Address

“**DEVICE LED ADDRESS**” option starts a countdown procedure of 25 minutes while every connected fire detection device indicates its address by a special flashing pattern that is repeating.

- 3burst short flash
- 2 seconds gap
- number of flashes multiplied by tens (with 1s gap between)
- 5 seconds gap
- 2burst short flash =>2s gap
- number of flashes multiplied by ones (with 1s gap between)
- 5 seconds gap
- repeat

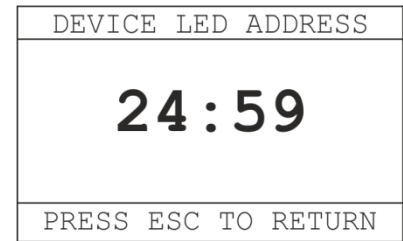

Figure5-7.Device led address

The address of the observed point is calculated by adding tens and ones. For example, address #124 will be indicated with the following pattern:

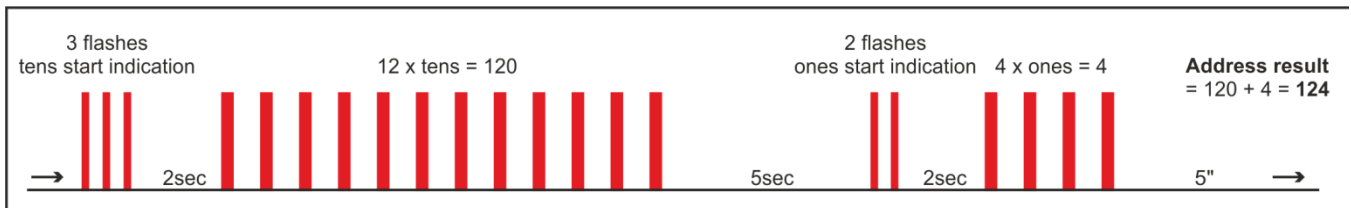

Figure5-8.Device led address pattern example of #124

5.2 Check Menu

This submenu is consisted of a set of inspection functions, used for system inspection, after initial installation or troubleshooting.

5.2.1 Check points

The first option “**POINTS**” displays the screen on the right, used to check communication quality between the control panel and a point (addressable device). Use up/down keys to navigate between addresses and left/right keys to navigate between loops.

The first section contains point’s information, first line displays points address (1.001 equals to loop 1, point address 1), second line displays point’s name and third line indicates point type (e.g. call point).

The next section contains point’s communication data. “**VALUE**” field indicates the point’s current reading value (fire detection), “**VALID PACKETS**” indicate the sum of the correct communication data packets received and “**INVALID PACKETS**” indicate the sum of the wrong data packets received. On normal conditions, only “**VALID PACKETS**” counter should increase.

POINTS
ADDRESS: 1.001
STAIRCASE 1ST
CALL POINT
VALUE: 10
VALID PACKETS: 110
INVALID PACKETS: 0

Figure5-9.Check point 1

Additional information for the selected points can be displayed by pressing the View Alarms key once. The additional information is “OPERATING HOURS” and “ALARM COUNTER” of the specific point.

POINTS
ADDRESS: 1.001 STAIRCASE 1ST CALL POINT
OPERATING HOURS: 870 ALARM COUNTER: 2

Figure5-10.Check point 2

5.2.2 Check loop communication

“LOOP COMMUNICATION” option shows the screen on the right, regarding the selected loop’s hardware data.

Navigate between the loops with up/down keys.

LOOP 1
LOOP VOLTAGEH: 28.57V LOOP VOLTAGEL: 18.73V
VALID PACKETS: 142 INVALID PACKETS: 0 VER.: 1.85

Figure5-11.Loop communication

5.2.3 Check conventional sirens

“CONVENTIONAL SIRENS” option will prompt for selecting a conventional siren output first. By clicking Enter key, the selected siren output will sound for 6 seconds and then stop, in order to confirm functionality of the circuits.

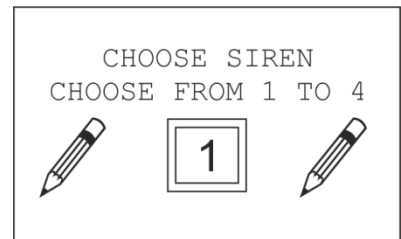

Figure5-12.Check conventional siren

5.2.4 Check relays

“RELAYS” will open another submenu to select a specific output relay for testing (test circuit functionality).

“FAULT” option will trigger the FAULT Relay output for 6 seconds.

“ALARM” option will trigger the ALARM Relay output for 6 seconds.

“AUX” option will trigger the AUX Relay output for 6 seconds.

“EXTRA RELAYS” option will prompt the technician to select one of the 8 extra relays and trigger the relay output for 6 seconds upon selection.

CHECK
FAULT ALARM AUX EXTRA RELAYS

Figure5-13.Check relays

5.2.5 Check voltage outputs

“**VOLTAGE OUTPUTS**” will display the screen on the right, for the technician to select one of the 24V generic outputs for testing. During testing the selected output will switch off for 6 seconds and switch on again. If the switching works, the control circuit shall be functional.

VOLTAGE OUTPUTS
24VM
24VP

Figure5-14. Check voltage outputs

5.2.6 Check network panels

“**NETWORK PANELS**” is a function used to check panel network communication (when activated).

When this option is selected via the Master control panel, the top line displays the name “**MASTER PANEL**” and the next line indicates the selected subpanel or repeater to check communication quality. Navigate between the subpanels and repeaters with up/down keys.

When this option is selected via a subpanel, the communication quality between this subpanel and the master panel is displayed.

The following lines describe the communication quality. On normal conditions only “**VALID PACKETS**” counter should increase.

The counter “**EVENTS QUEUE**” shows the events to be sent from and to the master panel.

MASTER PANEL
PANEL 2
VALID PACKETS: 46425
INVALID PACKETS: 0
NO ANSWER: 0
EVENTS QUEUE: 0

PANEL 2
VALID PACKETS: 46731
INVALID PACKETS: 0
EVENTS QUEUE: 0

Figures5-15. Check network panels

5.3 Setup menu

This submenu contains a series of configuration options for almost every segment of the fire detection system.

5.3.1 Points

"POINTS" option will prompt for selecting a specific point address. First select the point's loop and then its address. For 2 seconds the UID (Unique ID) and the name of the device will be displayed upon selection (screen on the right)

Next, the system will open a step-by-step configuration. The selections are appearing in the following order:

- Point type
- Zone (1 to 128)
- Operating mode
- State (enable or disable)
- Alarm (day alarm level)
- Alarm night (night alarm level)
- Prealarm (followed by its value when activated)
- Output mode (event to trigger point's output, remote LED or relay)
- Delay (time until the output of detector base is enabled after the selected trigger event)
- Output silence (if active, the output of the selected point will be de activated during SIREN SILENCE command).

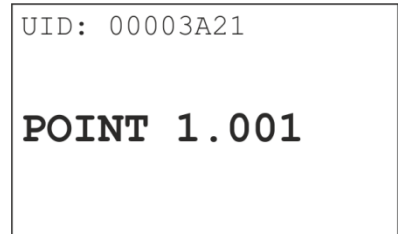

Figure5-16.Setup points 1

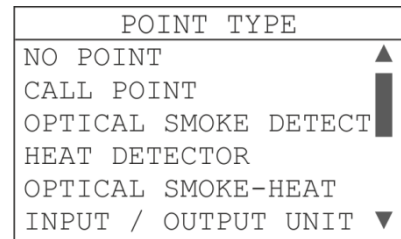

Figure5-17.Setup points 2

Some of the options above may not be visible to certain point types. Addressable sirens cannot be set to operate in FAULT output mode.

IMPORTANT! Heat detectors (BSR-6157 and BSR-6160) support both A1R (rate-of-rise) and A1S (fixed temperature) detecting modes and by default, A1R is enabled. The A1R / A1S operating mode setting is stored within the memory of the heat detector permanently. Restoring the control panel to factory default settings will not restore the operating mode of the heat detector to A1R, unless manually done.

5.3.2 Point detection

This option will erase all previous entries of registered points and start an automatic detection procedure. Every detected point will be automatically registered into the panel's memory.

IMPORTANT! This function will only work when installed points have already been addressed and does not alter points' addresses. The addresses in each loop shall be unique and not repetitive. Addressing the points can be done via Autoaddressing function or manually (change point address).

POINT DETECTION		
CURRENT ADDRESS		15
LOOP 1 ==>		15
LOOP 2 ==>		2
LOOP 3 ==>		7
LOOP 4 ==>		10
POINTS ==>		34

Figure5-18.Point detection

The preset name of the point will be “**POINT Y.XXX**” where Y the point’s loop and XXX the point’s address. The preset zone of each point will be equal to its loop (e.g. point 3.025 zone will be zone 3).

The first line, “**CURRENT ADDRESS**” indicates the current address under scanning. The following lines, from “**LOOP 1 to 4**”, indicate how many points have been detected so far in each loop separately. The last line, “**POINTS**” indicate the total number of detected devices.

The procedure will end until all 150 addresses have been scanned.

5.3.3 Autoaddressing points

The autoaddressing procedure is the easiest way to set addresses to all connected devices. The **prerequisites** for this procedure to operate is first to have an updated graphical installation plan and second the wiring of each loop should be according to chapter **4.3.1 Loop connections**, with no star connections or other modifications.

This option will also erase all previous entries of registered points and register new found points into memory, on the selected loop(s).

IMPORTANT! This function deletes all previously set addresses on all points and starts setting new address to each one. New addresses might differ from previous configuration, if one or more devices have been moved within a loop. If there is **BSR-8120** installed you should temporary disconnect the 24v power to the unit until the autoaddressing procedure is finished.

When this option is selected, the figure 5-19 on the right is shown. This option may be used to a single loop (e.g. 2) or to all of them.

When selecting single loop option, the control panel will ask for a loop number.

When selecting all loops option, the procedure will run through all 4 loops.

The system starts an initialization of all connected points that may last up to 20” seconds. Then one by one, each connected device on the loop (starting from loop 1), receives an address (starting from address 1, up to 150). The starting position is the first point connected on -L/+L terminals and the last is the last point, connected closer to -LF/+LF terminals of each loop.

The autoaddressing procedure will stop until the end of the loop has been reached, or a fault on the line has been detected [short-circuit, open loop or star connection (multiple points in parallel)].

The preset name of the point will be “**POINT Y.XXX**” where Y the point’s loop and XXX the point’s address. The preset zone of each point will be equal to its loop (e.g. point 3.025 zone will be zone 3)

During autoaddressing, the figure 5-20 is displayed. The first line indicates the current address to be assigned. The second line indicates the loop currently on autoaddressing mode and the last line indicates the total number of the registered points.

AUTOADDRESSING POINT
SINGLE LOOP
ALL LOOPS
CANCEL AUTOADDRES .

Figure5-19.Autoaddressing 1

AUTOADDRESSING POINT
CURRENT ADDRESS 15
LOOP 1 ==> 15
UID:XXXXXXXX
POINTS ==> 15

Figure5-20.Autoaddressing 2

5.3.4 Change point address

This option may be used in order to change a specific point's address, in purpose of replacement, adding new point or other modifications on the installation.

This function will send a command to change the address of all connected devices to the selected loop. Therefore, in order to change a point's address, connect the target point only, disconnect all other points (by removing the loop's detachable terminal). You can use a short 2-core cable to connect the -L/+L contacts directly on +IN/-IN of the point (no need for loop return).

When selecting this option, the system asks for the loop output to be used for changing a point's address. Make sure that you have selected the same loop that you have temporarily removed all of its other points. Select a loop and press Enter key.

Then the following screen on the right is shown. The "OLD" address, indicates the current address of the connected point. The "NEW" address indicates the selected address to be assigned. Use up/down keys to select another address and Enter key to confirm command.

CHANGE POINT ADDRESS CHOOSE FROM 1 TO 150	
OLD 019	NEW 001
ENTER TO CHANGE	

Figure5-21.Change point address

WARNING! Do not use this function while more than one addressable points are connected to the selected loop.

5.3.5 General resound

"GENERAL RESOUND" option will display the screen on the right.

By selecting YES, the general resound parameter is activated. This means that after sending "SIREN SILENCE" command on an alarm event, a new alarm event will trigger again the audible alarm signal, leading to siren resounding.

By selecting NO, this parameter is inactive, meaning that when the audible alarm is on silence, a new alarm event will keep the sirens silent.

"SIREN SILENCE / RESOUND" key functionality is not altered by the option above. Silencing and re-enabling manually the sirens is always available.

Please note that when a network of panels has been installed, all subpanels must have the same setting with the master panel.

GENERAL RESOUND
YES
NO

Figure5-22.General resound

5.3.6 Conventional sirens

"CONVENTIONAL SIRENS" option will display the screen on the right, where you can select the activation of the siren output. By default all conventional siren outputs are enabled on general alarm.

First, you have to select the siren output. Select the output number (1 to 4) and press Enter. The configuration steps are appearing with the following order:

- On alarm: Select delay from 0-10 minutes and selecting NO you choose if it will be activated at SIREN SILENCE. By selecting NO 2

SIREN MODE
ON ALARM
ON PREALARM
ON SPECIFIC ZONE
ON TASK

Figure5-23. Setup conv. sirens

choices are appeared NO/YES, if you select YES then by pressing the SIREN SILENCE button the output will stop. By selecting NO the output will stop only after a RESET.

- Pre-alarm: Same choices with the alarm menu.
- On a specific zone: Select task, delay (from NO up to 10 minutes) and YES or NO at SIREN SILENCE.
- On task: Select task, delay (from NO up to 10 minutes) and YES or NO at SIREN SILENCE.

Note: To program combinations you have to use the PC software.

5.3.7 AUX Relay

“**AUX RELAY**” option will open a step-by-step configuration to setup the auxiliary relay. By default AUX relay is triggered by alarm. The configuration steps are appearing with the following order:

- Output mode (alarm/fault/prealarm/zone/task) *
- Relay logic (positive/negative initial output position)
- Delay (switching delay after triggering event)
- Relay silence (select if the aux relay output will switch to initial position after “SIREN SILENCE” command is given)

OUTPUT MODE
DISABLE
ON ALARM
ON FAULT
ON PREALARM
ON SPECIFIC ZONE
ON TASK

Figure5-24.Setup AUX relay

5.3.8 Extra Relays

“**EXTRA RELAYS**” option, similarly to AUX relay, will open a step-by-step configuration to setup the extra relays. By default extra relays are triggered by alarm. The configuration steps are appearing with the following order:

- Select extra relay (1 to 8)
- Output mode (alarm/fault/prealarm/zone/task) *
- Relay logic (positive/negative initial output position)
- Delay (switching delay after triggering event)
- Relay silence (select if this extra relay output will switch to initial position after “SIREN SILENCE” command is given)

OUTPUT MODE
DISABLE
ON ALARM
ON FAULT
ON PREALARM
ON SPECIFIC ZONE
ON TASK

Figure5-25.Setup extra relays

*when a relay output (aux/extra) is set to FAULT event, after a fault triggering event, only RESET will switch the relay back to normal position. Combination of outputs is configurable only via the PC software.

5.3.9 Panel Network

“**PANEL NETWORK**” submenu contains the options listed on the screen on the right.

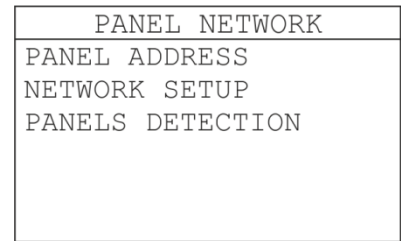

Figure5-26.Panel network

First option, “**PANEL ADDRESS**” will open an input window to configure the control panel’s address within the network of panels. Each address must be unique. Address number 1 is given to the master control panel. Addresses 2, 3 and 4 are given to subpanels.

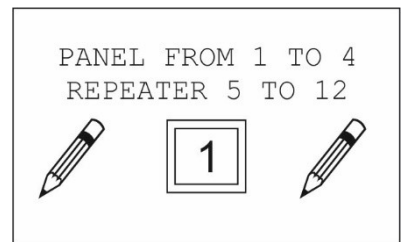

Figure5-27.Panel address

Second option, “**NETWORK SETUP**” is used to enable or disable panel networking on a control panel. When set to enable, a master panel enables data transmission via the RS-485 port and a subpanel reads transmitted data via the same port.

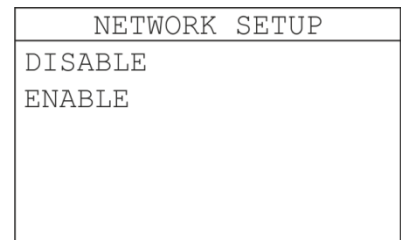
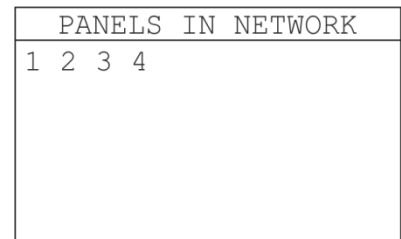
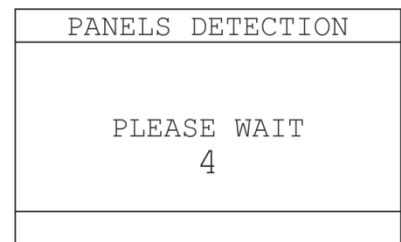

Figure5-28.Network setup

Third option, “**PANELS DETECTION**” starts a scanning sequence and registers all found subpanels into memory (for master panel only). This function is crucial for a panel network to operate, after enabling it.

At the end of the scanning a result of the detected panels will appear for 2 seconds (second screen on the right).



Figures5-29.Panels detection

5.3.10 Loops

“**LOOPS**” option displays the screen shown on the right. Via this selection screen, the technician can register / unregister loop circuits. Use up/down keys to navigate between the loops and right key to select or unselect activation. Press Enter to save configurations.

This option may only be used when removing a loop card or adding a new one. Do not unregister an installed loop circuit or register a not installed one, as a relative fault will appear on the control panel screen.

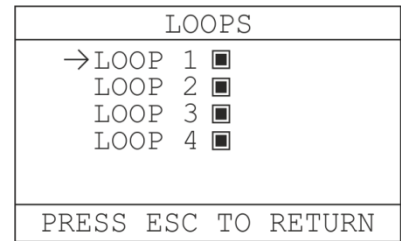

Figure5-30.Setup loops

5.3.11 Max indicators per loop

“**MAX INDICATORS/LOOP**” option is used to restrict the maximum number of lit LED indicators, of the connected addressable devices in a loop, during an alarm event, in order to reduce high current consumption that could lead to malfunctions.

When the maximum number of allowed indicators is reached, the rest of the devices that may detect a fire, will send the fire alarm signal to the control panel but will not turn on their red LED indicator. By default set to 10.

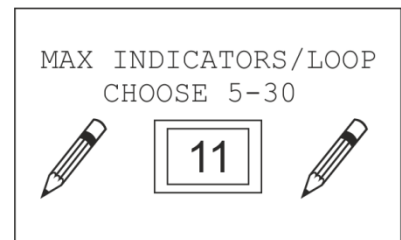

Figure5-31.Max indicators/loop

5.3.12 Detectors dependency

“**DETECTORS DEPENDENCY**” option will display the submenu shown to the right.

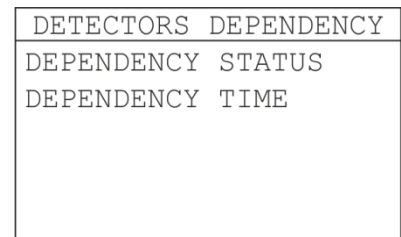

Figure5-32.Detector dependency

The first option “**DEPENDENCY STATUS**” is used to set the “dependency” as enabled or disabled. This term means that the smoke/fire detectors will not instantly trigger alarm event when the detected value is above limit, but will go through a selected time delay, in which the detected alarm value should be constantly above selected limit.

This function may be used as a “sensitivity” setting, indirectly.

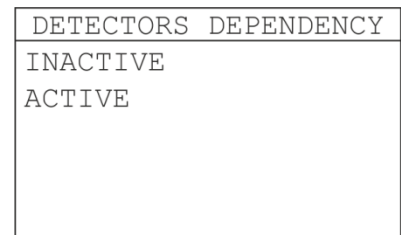

Figure5-33.Dependency status

The second option “**DEPENDENCY TIME**” sets the delay time that takes place before triggering an alarm event on the control panel, after a smoke/fire detection points has detected a value above limit. The available time delays are:

20s / 30s / 40s / 50s / 1m

The detected value must remain above limit for the selected period of time constantly in order for the alarm event to be triggered.

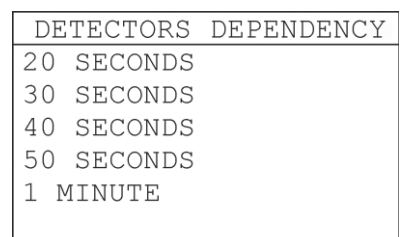

Figure5-34.Dependency time

5.3.13 Indication of points

“**INDICATION OF POINTS**” option is used to enable or disable the red LED indicator blinking on the addressable points. Useful on areas (e.g. hotels) that LED blinking might bother inhabitants or other special events.

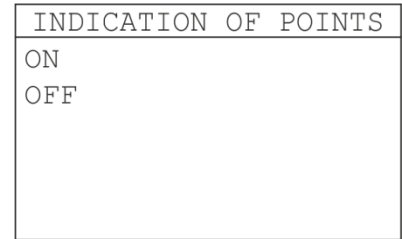

Figure5-35.Indication of points

5.3.14 Delete points

“**DELETE POINTS**” option is used in order to delete specific point entries from the memory, all points of a loop or all registered points in the control panel. The three available options are the following:

- DELETE SINGLE POINT (delete a single point only)
- DELETE LOOP (delete all registered points in a loop)
- DELETE ALL POINTS (delete all registered points)

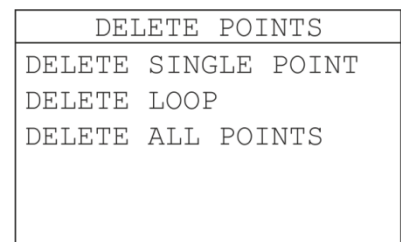
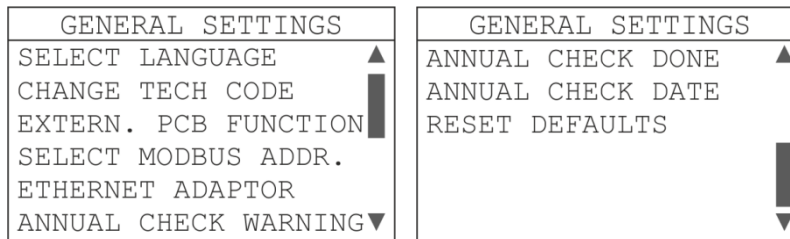

Figure5-36.Delete points

5.4 General settings

This section contains details regarding the general settings menu. When selecting “**GENERAL SETTINGS**” via technician menu, the following options appear:



Figures5-37.General settings menu

5.4.1 Select language

First option, “**SELECT LANGUAGE**”, opens the available languages window to change control panel’s menu language, including event log records.

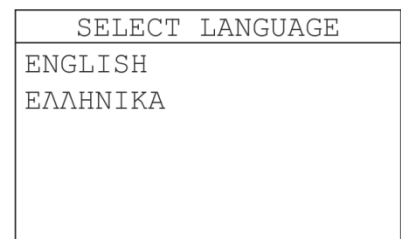

Figure5-38.Select language

5.4.2 Change technician code

“**CHANGE TECH CODE**” option will display the screen on the right, asking the technician to enter a new code for access level 3. After inputting the code, the panel asks to enter the new code again for confirmation.

WARNING: Changing the technician’s code is an action that must be taken responsibly. If the code is lost there is not any possible way to reset the technician code back to default.

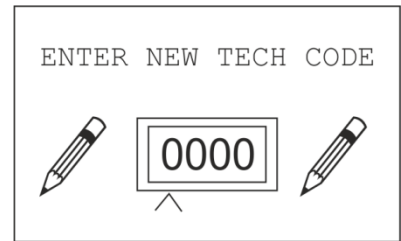

Figure5-39.Change tech code

5.4.3 External PCB function

“**EXTERN. PCB FUNCTION**” option is used to select the preferred optional expansion functionality. The expansion adaptor may not be pre-installed (optional), therefore in order to operate a mode must be given via this menu. The available options are:

- NONE (when no expansion card is installed)
- PRINTER (when printer adaptor for A-200 printer is installed)
- MODBUS (when MODBUS adaptor is installed)

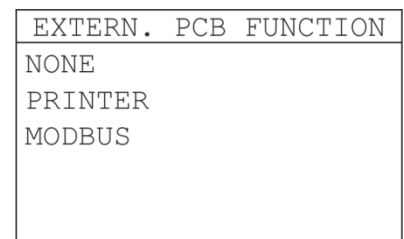

Figure5-40.External PCB

5.4.4 Select MODBUS address

“**SELECT MODBUS ADDR.**” option is used to set current control panel’s address for the MODBUS network. Available addresses are 1 to 247.

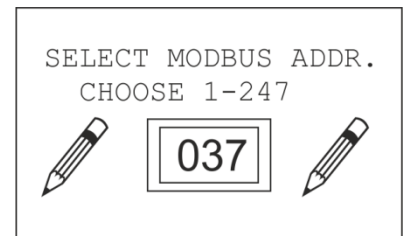

Figure5-41.Select MODBUS addr

5.4.5 Ethernet adaptor

“**ETHERNET ADAPTOR**” option displays a submenu displayed on the screen on the right.

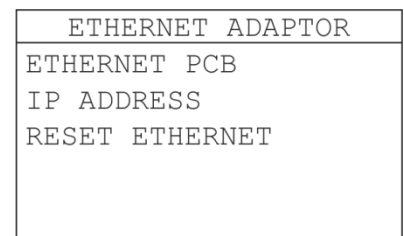

Figure5-42.Ethernet adaptor

The first option “**ETHERNET PCB**” is used to enable / disable the Ethernet adaptor. Enable the Ethernet adaptor only when a GR-8530 Ethernet adaptor card is installed into the panel.

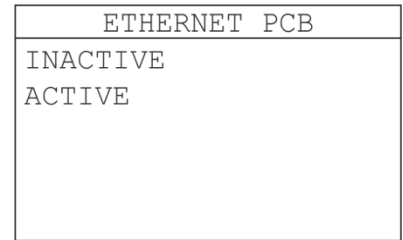

Figure5-43.Ethernet PCB

Next option, “**IP ADDRESS**” is used to configure the control panels IPv4 address to connect to the local network (LAN). The address is static (no DHCP).

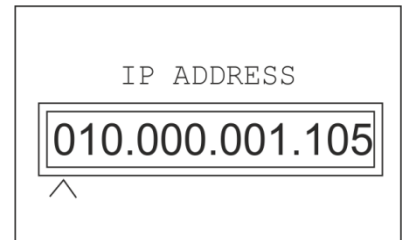

Figure5-44.IP Address

Last, “**RESET ETHERNET**” option re-initiates the Ethernet adaptor to fix connection issues or used after IP changing to move to the new IP.

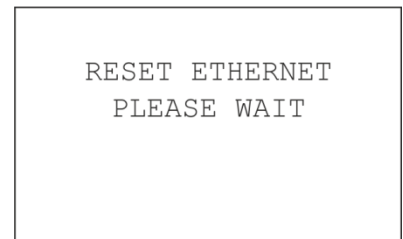

Figure5-45.Reset Ethernet

5.4.6 Annual check warning

“**ANNUAL CHECK WARNING**” option enables / disables an indication message that appears every year as a warning for maintenance.

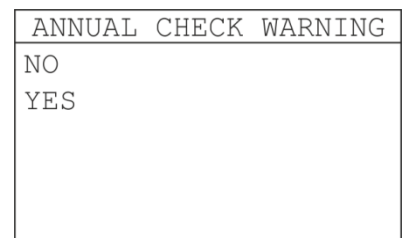

Figure5-46.Annual check warning

5.4.7 Annual check done

“**ANNUAL CHECK DONE**” postpones the annual check warning for next year, meaning that this year maintenance has been done successfully.

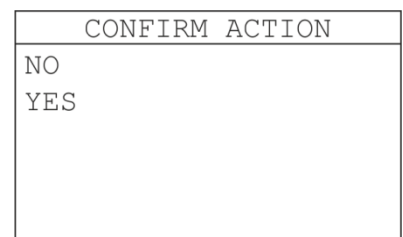

Figure5-47.Annual check done

5.4.8 Annual check date

“**ANNUAL CHECK DATE**” option indicates the next scheduled maintenance date.

ANNUAL CHECK DATE
25/02/20
PRESS ESC TO RETURN

Figure5-48.Annual check date

5.4.9 Reset defaults

“**RESET DEFAULTS**” clears memory and restores all configurations back to factory default values.

The only exceptions are certain hardware configurations:

Loops (enabled/disabled), External PCB function, Ethernet PCB (enabled/disabled).

CONFIRM ACTION
NO
YES

Figure5-49.Reset defaults

5.5 Clear events log

The “**CLEAR EVENTS LOG**” option deletes all event log entries in the control panel. This option should be executed after every initial installation so event logs during commissioning are cleared and real time operation events are logged.

CONFIRM DELETION
NO
YES

Figure5-50.Clear events log

5.6 Initializing alarm counter

The “**INIT. ALARM COUNTER**” option is used to reset the alarm counter back to “0”. The number of recorded alarms can be seen in “MENU > INFORMATION > ALARMS COUNTER”.

This option is only accessible with level 4 access, meaning that the technician must have physical access to the dip-switch selector on the back side of the CPU board and switch selector 1 to ON position. After executing this function, dip-switch selector 1 shall be set back to OFF position.

INIT. ALARM COUNTER
NO
YES

Figure5-51.Init. alarm counter

5.7 PC Communication

The “PC COMMUNICATION” option is used to download/upload configurations from or to a PC via USB cable, running the **BSR-100X software application**. When selected, a confirmation message as the screen on the right will be displayed. When the PC communication starts, the control panel will be awaiting for a request from the PC.

During data transmission or reception, a relative message (TRANSMITTING DATA or RECEIVING DATA) will appear on screen.

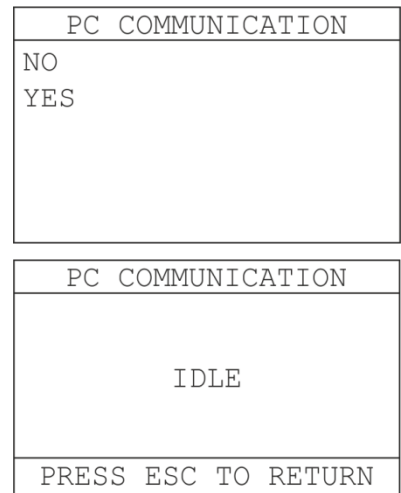

Figures5-52.PC Communication

5.8 Technician’s Menu on Ethernet

The control panel’s programming can be made with the keypad in front of the panel. Alternatively, many options are available via PC (web browser). The factory’s default IP address is **10.0.9.105**.

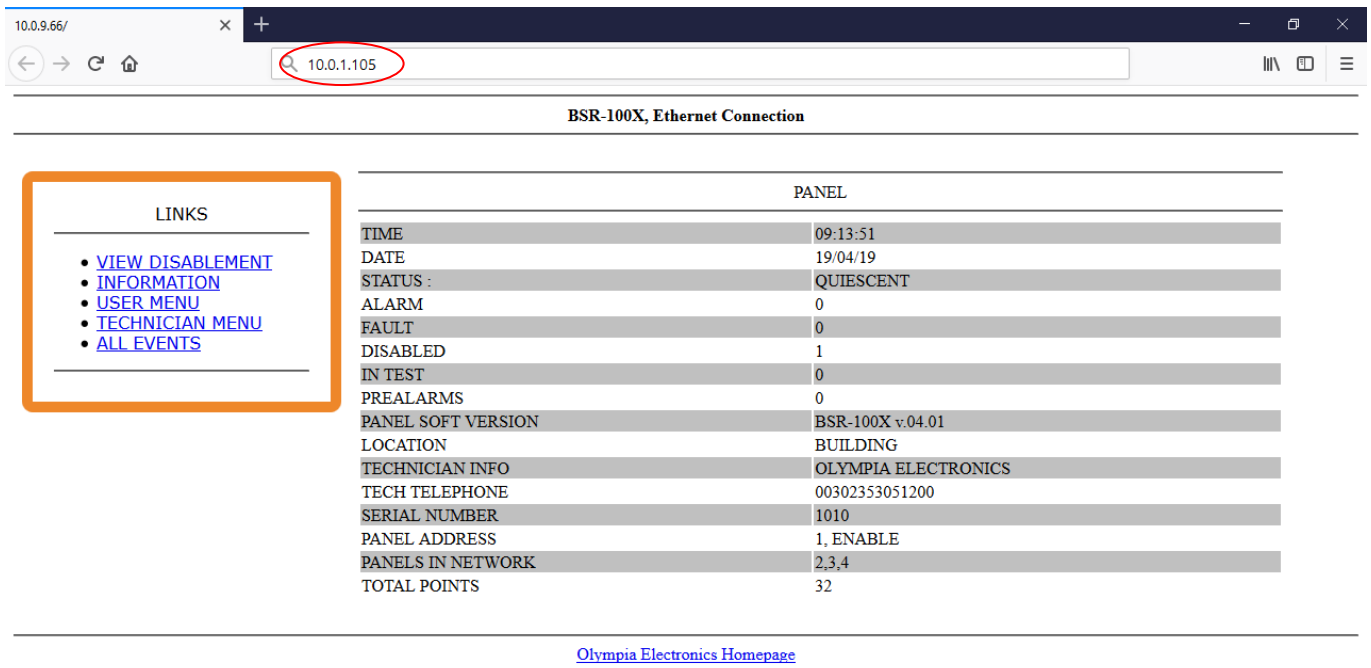

When “TECHNICIAN MENU” link is clicked, the control panel asks for technician code.

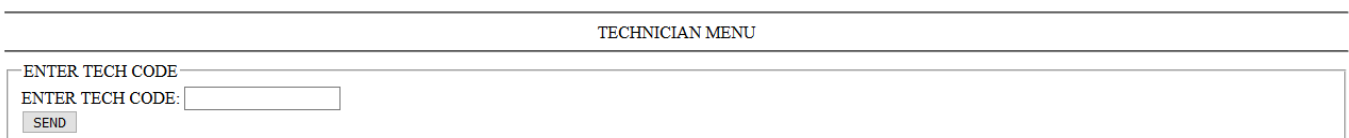

Write the code in the text box and click send. If the code is correct the technician menu appears.

TECHNICIAN MENU

<ul style="list-style-type: none"> • INDICATION OF POINTS • MAX INDICATORS/LOOP • DETECTORS DEPENDENCY • GENERAL RESOUND <hr style="width: 50%; margin: 5px auto;"/> <ul style="list-style-type: none"> • PANEL NETWORK • PANELS DETECTION 	<ul style="list-style-type: none"> • ANNUAL CHECK DONE • ANNUAL CHECK WARNING <hr style="width: 50%; margin: 5px auto;"/> <ul style="list-style-type: none"> • SELECT LANGUAGE • SELECT MODBUS ADDR. • IP ADDRESS • CLEAR EVENTS LOG • CHANGE INFORMATION • RESET DEFAULTS
--	--

[\[MAIN PAGE\]](#)

The menu design is similar to the corresponding panel’s menu. Although some functions can be made exclusively by using the Ethernet menu, (e.g. “CHANGE INFORMATION”).

The following paragraph is describing the new options available to configure via web interface that were not present via the keypad.

5.8.1 Change information

By selecting “**CHANGE INFORMATION**” link the page below appears.

CHANGE INFORMATION

LOCATION	<input type="text" value="BUILDING"/>
TECHNICIAN INFO	<input type="text" value="OLYMPIA ELECTRONICS"/>
TECH TELEPHONE	<input type="text" value="00302353051200"/>
PANEL NAME	<input type="text" value="PANEL"/>
<input type="button" value="SAVE"/>	

[\[TECHNICIAN MENU\]](#)

Write down the contractor’s contact information and the panels name and click “**SAVE**”.

“LOCATION” – up to 24 characters,

“TECHNICIAN’S INFORMATION” – up to 24 characters,

“TECHNICIAN’S TELEPHONE” – up to 16 digits.

By selecting the “**TECHNICIAN MENU**” link the page is redirected back to technician’s menu, without saving any changes.

6 Initial installation procedure

The initial installation of the BSR-100X Analogue Addressable Fire Alarm systems comes with an advanced “tool” that automatically sets the address of each point in a loop, to save time and make installation easier. This “tool” is a procedure called “**Autoaddressing**” and is accessible via technician menu (chap.5.2.3). During this procedure, the control panel starts assigning addresses from 1, across the loop, starting from the first point connected closer to –L/+L terminal output of a loop. Then, address number 2 is given to the second in-line point, and goes on until the end of the loop.

There are some prerequisites for this procedure in order to run flawlessly, in terms of loop design and wiring (chap.4.7).

First, the most significant rule is that the points of a loop are connected in line, strictly in a loop, without any star connections (points in parallel) or open circuit. All points should be connected with correct polarity and all detectors should be placed on their detachable base.

The cable passing across the loop must be in accordance with the initial installation plan; otherwise it will be difficult to identify the address of each point in the loop.

All addressable devices for the BSR-100X system include a double sticker with a 10 digit (hexadecimal) code and a barcode that represents this number. This sticker on the BSR-6155, BSR-6157 and BSR-6160 detectors is placed on the back surface, facing its base. On the rest of the devices this sticker is on a visible area. The first 2 digits of this code refer to the device type and the rest 8 digits refer to the **UID** of the device (Unique identification code).



In the package an accompanying leaflet named “BSR-100X Loop Codes” is present which contains a list of 150 addresses of each loop.

During installation of points (addressable devices) one sticker with the unique code and barcode of each device, must be removed and then placed on the “BSR-100X Loop Codes” leaflet, in the corresponding address and loop, where each point is placed. The “Location” area is to write down the point’s location (equal to point’s name). On the following figure an example can be seen of a device placed on address 1 to loop 1.

BSR-1004 PANEL		Loop 1	Addresses 1 - 21	
				
Point 1.001	Point 1.008	Point 1.015		
UID	UID	UID		
Location	Location	Location		
ROOM 214				
Point 1.002	Point 1.009	Point 1.016		
UID	UID	UID		
Location	Location	Location		
Point 1.003	Point 1.010	Point 1.017		
UID	UID	UID		
Location	Location	Location		

	Date	9/6/2022
	Document number	921100400_09_005
	Page	62 of 71

When the installation of every addressable device, conventional siren and other peripheral has been completed, then a series of loop wiring tests must be executed before powering on. To do the following steps simply remove the detachable loop terminal blocks from its/their sockets.

Use a resistor meter (e.g. a multimeter) to measure resistance to the following contacts:

- Resistance between **+L** (start) and **+LF** (finish) contact directly on the detachable terminal of each loop (cable side, to measure loop cable). Depending on cable length and cross-section, the resistance should be less than 25Ω.
- Resistance between **+L** (start) and **“Protective Earth”** (panel’s ground). The resistance should be over 10MΩ.
- Resistance between **+LF** (finish) and **“Protective Earth”** (panel’s ground). The resistance should be over 10MΩ.
- Resistance between **-L** (start) and **“Protective Earth”** (panel’s ground). The resistance should be over 10MΩ.
- Resistance between **-LF** (finish) and **“Protective Earth”** (panel’s ground). The resistance should be over 10MΩ.
- Last, measure the two cable shielding ends. The resistance should be less than 50Ω.

When all measurements above are within limits, connect the tested loop terminal block back to the board socket

When all loop wirings have been tested, confirm that all other connections are correct and then connect the batteries and supply mains power to the panel (230VAC) to power on.

Now you can proceed to commissioning, starting with **“Autoaddressing”** to set addresses to all connected addressable devices automatically (TECHNICIAN MENU > SETUP > AUTOADDRESSING > ALL LOOPS). When the autoaddressing procedure ends, if the installation was made according to plan, then the control panel will have registered into memory the exact number of devices mentioned in plan.

The preset name of the point will be **“POINT Y.XXX”** where Y the point’s loop and XXX the point’s address. The preset zone of each point will be equal to its loop (e.g. point 3.025 zone will be zone 3).

Right after this step, the fire detection mechanism on this panel is armed and ready.

One of the major advantages of an analogue addressable fire alarm system is that the source of the alarm event can be identified. In many systems, the name of each fire detection device can be modified according to the installed location, to help a user locate a fire event quickly. The name of each point registered on the BSR-100X control panel can be changed (via PC software application and USB cable) so a default name such as **“POINT 2.014”** can be renamed to **“ROOM 214”** or **“STAFF ROOM 2”**. In case of an alarm, a prealarm or a fault event, this name will appear on screen. Logged events also keep a record of the name.

When the point addressing and registration has been completed, the panel should be in **quiescent** state. No faults, alarms or prealarms should be active and the control panel’s screen should display the message **“SYSTEM READY”**.

Full access to the BSR-100X control panel’s programming options can be granted via the **BSR-100X PC software application** by **Olympia Electronics**. You can download the software directly by the official Olympia Electronics website for free:

<https://www.olympia-electronics.com/en/support/software>

See chapter 7 for further information.

7 BSR-100X PC software application

7.1 *Programming the panel*

In order to connect the BSR-100X control panel to a PC, a Mini-USB 2.0 cable will be needed. The Mini-USB port on the control panel is located on the back side of the CPU board, above the lock mechanism. See the photos below:

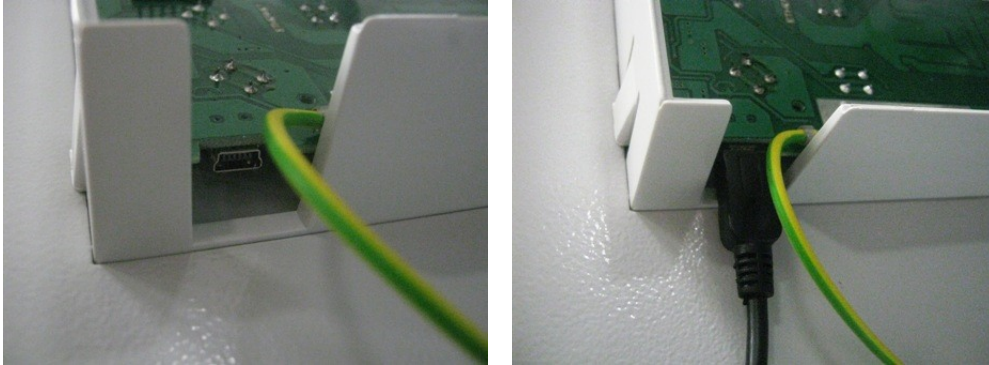

Photos: Mini-USB connector on the CPU board position.

Install the **BSR-100X** software application to a Windows PC, connect the control panel to the PC to an available USB port on the PC and launch the application.

Once you have completed the installation of the Fire Alarm System and you have executed addressing procedures (chapter 4.2), then you can proceed with configuring other special parameters, renaming segments, etc.

Use the control panel's keypad and go to:

TECHNICIAN MENU > PC COMMUNICATION > YES

Then on the BSR-100X software, select:

Panel Communication > Setup

And a communication window appears:

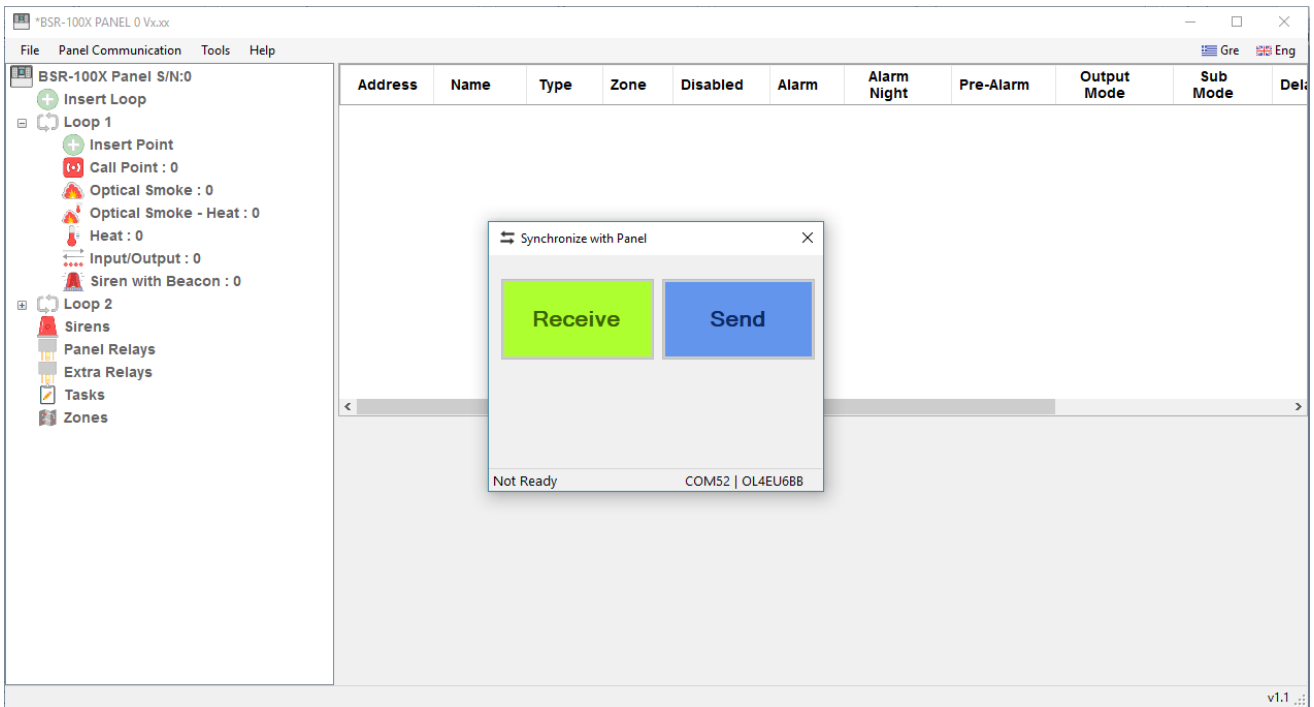

When the BSR-100X control panel is detected, the message “Ready” will be displayed on the bottom line of the **“Synchronize with Panel window”**. To receive control panel configuration file, click on **“Receive”** button. When the progress bar is filled, the window will close automatically.

Now you can proceed with configuring panel parameters. Right click on the **“BSR-100X Panel SN:”** entry on left column and select **“Edit parameters”**. A window appears with 5 tabs that include multiple options and parameters regarding the panel’s data.

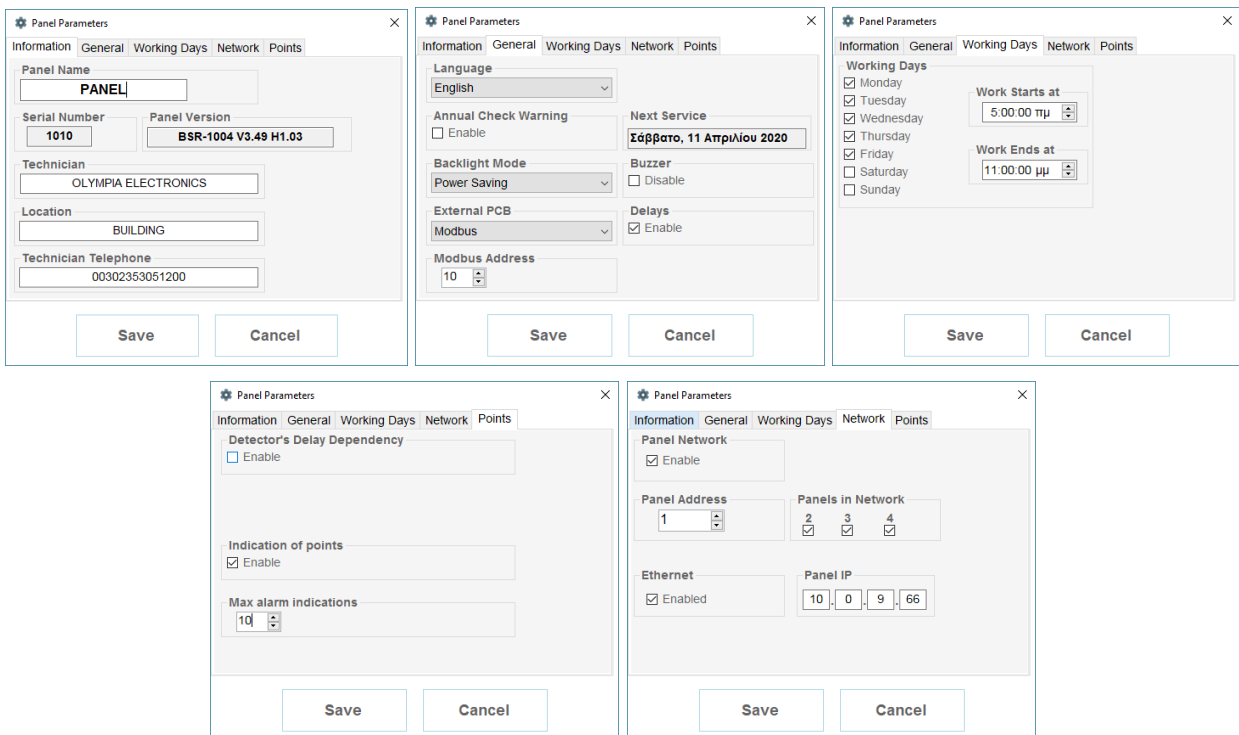

The first tab **“Information”** is where you can change the name of the panel and the technician’s contact information. The rest of the tabs include the same options which can be accessed via the control panel’s screen and keypad. When finished, click on **“Save”** button.

Now proceed with configuring other parameters, such as detector **alarm limits** and **names**. Click on a loop entry on the left column. All registered points in this loop, appear on the right section of the screen. When an entry is selected, its data is displayed on a form below:

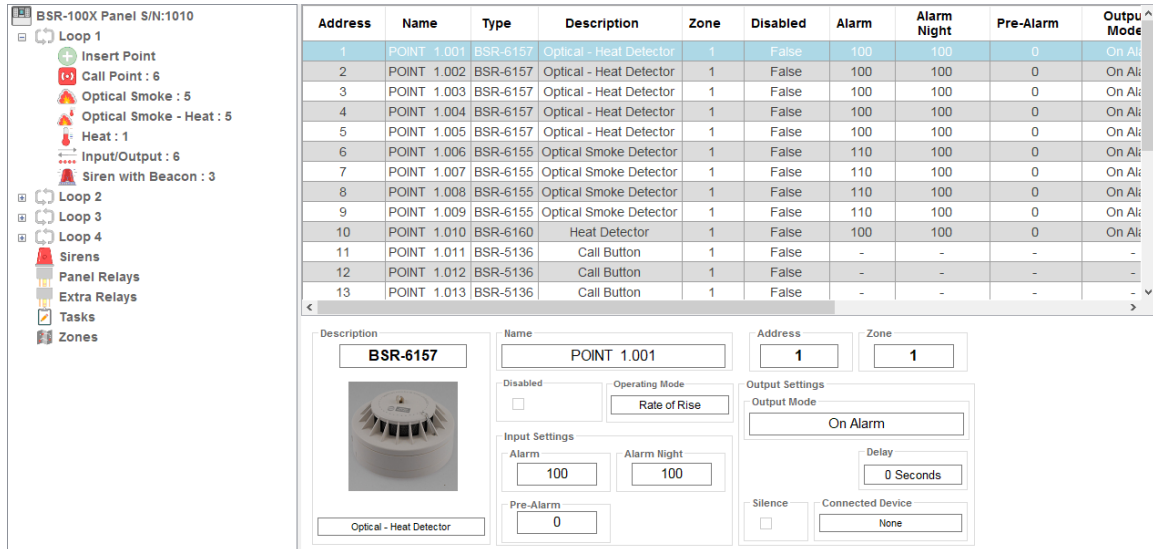

Address	Name	Type	Description	Zone	Disabled	Alarm	Alarm Night	Pre-Alarm	Output Mode
1	POINT 1.001	BSR-6157	Optical - Heat Detector	1	False	100	100	0	On Al
2	POINT 1.002	BSR-6157	Optical - Heat Detector	1	False	100	100	0	On Al
3	POINT 1.003	BSR-6157	Optical - Heat Detector	1	False	100	100	0	On Al
4	POINT 1.004	BSR-6157	Optical - Heat Detector	1	False	100	100	0	On Al
5	POINT 1.005	BSR-6157	Optical - Heat Detector	1	False	100	100	0	On Al
6	POINT 1.006	BSR-6155	Optical Smoke Detector	1	False	110	100	0	On Al
7	POINT 1.007	BSR-6155	Optical Smoke Detector	1	False	110	100	0	On Al
8	POINT 1.008	BSR-6155	Optical Smoke Detector	1	False	110	100	0	On Al
9	POINT 1.009	BSR-6155	Optical Smoke Detector	1	False	110	100	0	On Al
10	POINT 1.010	BSR-6160	Heat Detector	1	False	100	100	0	On Al
11	POINT 1.011	BSR-5136	Call Button	1	False	-	-	-	-
12	POINT 1.012	BSR-5136	Call Button	1	False	-	-	-	-
13	POINT 1.013	BSR-5136	Call Button	1	False	-	-	-	-

Double click on a point to edit name and parameters.

In the name textbox you can edit the name of each device. Edit all other parameters according to the installation needs. The last option, "**Connected Device**" has no effect on the control panel and is only used on the software for loop and battery calculation tools.

When finished, click on "**Save**" button to save all configurations for this point.

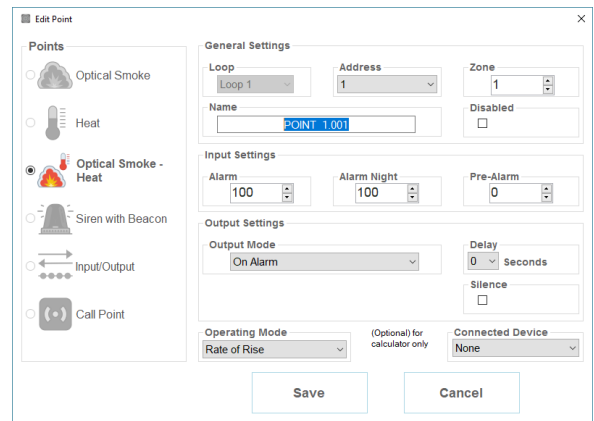

Edit Point

Points: Optical Smoke, Heat, Optical Smoke - Heat, Siren with Beacon, Input/Output, Call Point

General Settings: Loop (Loop 1), Address (1), Zone (1), Name (POINT 1.001), Disabled (False)

Input Settings: Alarm (100), Alarm Night (100), Pre-Alarm (0)

Output Settings: Output Mode (On Alarm), Delay (0 Seconds), Silence (False)

Operating Mode: Rate of Rise (Optional for calculator only), Connected Device (None)

Buttons: Save, Cancel

You can also edit values on multiple points by selecting multiple entries (using Ctrl on PC keyboard). Right click and select which parameter you need to edit in multiple points.

Address	Name	Type	Description	Zone	Disabled	Alarm	Alarm Night	Pre-Alarm	Output Mode
1	POINT 1.001	BSR-6157	Optical - Heat Detector	1	False	100	100	0	On Al
2	POINT 1.002	BSR-6157	Optical - Heat Detector	1	False	100	100	0	On Al
3	POINT 1.003	BSR-6157	Optical - Heat Detector	1	False	100	100	0	On Al
4	POINT 1.004	BSR-6157	Optical - Heat Detector	1	False	100	100	0	On Al
5	POINT 1.005	BSR-6157	Optical - Heat Detector	1	False	100	100	0	On Al
6	POINT 1.006	BSR-6155	Optical Smoke Detector	1	False	110	100	0	On Al
7	POINT 1.007	BSR-6155	Optical Smoke Detector	1	False	110	100	0	On Al
8	POINT 1.008	BSR-6155	Optical Smoke Detector	1	False	110	100	0	On Al
9	POINT 1.009	BSR-6155	Optical Smoke Detector	1	False	110	100	0	On Al
10	POINT 1.010	BSR-6160	Heat Detector	1	False	100	100	0	On Al

Edit Alarm Value

New Alarm Value

100

OK

Similarly to points' configuration, you can edit other segments of the control panel (conventional sirens, panel relays, extra relays, tasks and zones) by selecting a group entry on the left column.

After finishing with the configurations (names, zones, tasks, behavior etc.), **save a copy** of the configuration file:

File > Save As

Keep this configuration file copy on a safe location which can be later used to restore this data.

To transfer the new configuration file, go to:

Panel Communication > Setup > Send

(The control panel must be on **“PC COMMUNICATION”** mode in technician menu)

Once the progress bar is filled, the control panel has been updated with the new configurations. By pressing ESC key on the keypad, the control panel will self-reset, apply changes and go back to main screen.

IMPORTANT! Via the same **“PC COMMUNICATION”** mode on the control panel, the technician is able to **receive event log, synchronize time** with the PC, and **confirm annual check**. All these options can be selected in **“Panel Communication”** option.

7.2 Loop calculation

From the menu select **TOOLS > LOOP CALCULATION:**

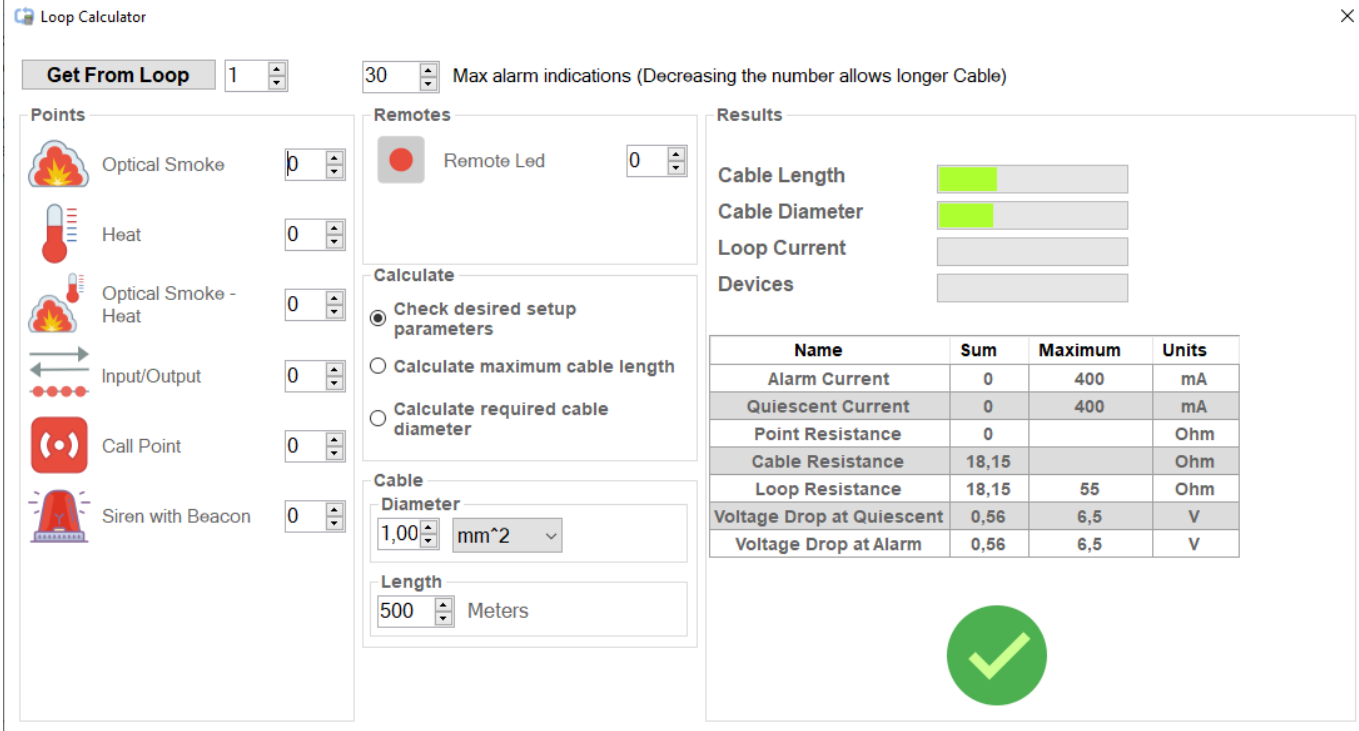

Name	Sum	Maximum	Units
Alarm Current	0	400	mA
Quiescent Current	0	400	mA
Point Resistance	0		Ohm
Cable Resistance	18,15		Ohm
Loop Resistance	18,15	55	Ohm
Voltage Drop at Quiescent	0,56	6,5	V
Voltage Drop at Alarm	0,56	6,5	V

This tool is used before the installation of the points on each loop. On the left column choose the number of points you want to install, select if there are external LED and the number of the indications will be activated in case of alarm. Selecting the siren with beacon and choose wisely the DIP-switch you will use so the calculation will be correct. Then you can choose what you will calculate. You will have 3 choices:

- Test of the selected parameters: Select the section and the length of the cable.
- Calculation of maximum length of the cable: Select the section of the cable.

- Calculation of the required section of the cable: Select the length of the cable.

On the left column the results are shown. At the top of the screen there are bars changing color depending on the result and at the bottom of the screen there is a detailed table with the results based on the selections we made.

7.3 **Battery Calculation**

From the menu select TOOLS > BATTERY CALCULATION and the picture below is appeared:

Battery Calculator
✕

ΠΙΝΑΚΑΣ

Loop 1 0 Points

Loop 2 -

Loop 3 -

Loop 4 -

Siren 1 mA

Siren 2 mA

Siren 3 mA

Siren 4 mA

Panel Relays 2

Extra Relays 8

24VM mA

24VP mA

Results in mA

	In Fault	In Alarm
Loops	0	0
Relays	5,4	116,2
Sirens	0	17,2
24VM & 24VP	0	0
Panel	39,5	39,5
Total	44,9	172,9

Battery Needed : 4,1 Ah

Suggested Battery : 7 Ah



It calculates the required battery for the duration of 72 hours of standby and the remaining power for 30 minutes of alarm according to the standards of EN-54 series.

If we want to calculate the required battery for future installation, we have to create a virtual installation through the program and we have to select battery calculation.

8 BSR-1000 Repeater panel

8.1 **General**

The BSR-1000 is a repeater for BSR-100x series panels and allows the general monitoring of the system. The BSR-1000 through its build-in screen and keypad can show panel network events, current and recorded, and user can perform basic control of panel network.

8.2 Functions

Similar to BSR-1001-2-4 the BSR-1000 has the same functionality as far as the indicators, screen and keypad concerns, as well as the Menu structure. The only difference is some functions limitation, i.e. the screen on the right is shown on menus that repeaters cannot access, preventing wrong actions.

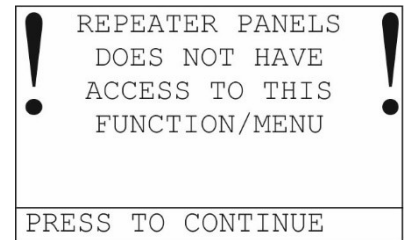

Εικόνα8-1. Limited acces to repeaters

8.3 Installation

Repeater installation should be carried out in the same way as in other BSR-100x series panels
Follow the instructions on chapter 4 for the repeater installation

8.4 Wiring

The connection of the repeaters is made through the RS-485 protocol. The existing network panel is used for the connection of the repeaters. The panel network should be implemented by 1 master panel and up to 3 subpanels and up to 8 repeaters, up to 12 total panels in network. The wiring should be carried out according to the instructions on chapter 4.5

8.5 Setup repeater network

The repeater has a default address 5. For proper operation it is necessary to setup the network panel. Prior to any network setup, the address on each repeater and subpanel should be set and after that address 1 on master panel should be set for network identification.

8.5.1 Setup repeater address

Repeater address is set from the **“TECHNICIAN MENU”** on the submenu **“SETUP”** by selecting **“PANEL NETWORK”**. Select address 1 for the master panel, 2-3-4 for the subpanels and 5-6-7-8-9-10-11-12 for the repeater panels. Next select **“NETWORK SETUP”** and **“ENABLE”**. This procedure is repeated for every panel connected to panel network.

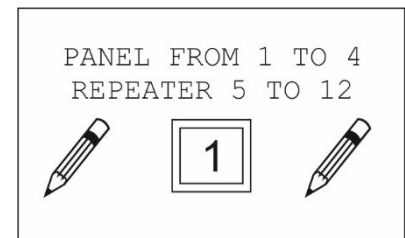

Εικόνα8-2. Panel network address

ATTENTION! Do not set repeater address 5-12 in master panel – subpanels or master – subpanel address 1-4 to repeater panel.

8.5.2 Panel network detection

In order to complete panel network setup, electrical connection to the mains network as well as connection between the panels with the RS-485 network should be carried out. Then address 1 is set to master panel from **“TECHNICIAN MENU”** on submenu **“SETUP”** by selecting **“PANEL NETWORK”**, then select **“NETWORK SETUP”** and **“ENABLE”** and finally select **“PANELS DETECTION”**. During panel detection master panel will detect every active subpanel and repeater which is available on the network. Eventually, the master panel will return to main screen. In order to view the detection results select from the master panel **“INFORMATION”** on the main menu and then select **“NETWORK PANELS”** and **“ACTIVE ADDRESSES”**.

9 Technical Characteristics – Properties

Description	BSR-1001 Analogue Addressable Fire Alarm Panel 1 Loop / 128 Zones	BSR-1002 Analogue Addressable Fire Alarm Panel 2 Loops / 128 Zones	BSR-1004 Analogue Addressable Fire Alarm Panel 4 Loops / 128 Zones
Mains power input	220-240VAC/50-60Hz		
Consumption	130VA max		
Battery type	2 x lead-acid batteries (Pb) 12V / 7-15Ah		
Charger	Stabilized power supply 27,6V / 900mA		
Loop circuits	1 loop 150 addressable points 400mA max current	2 loops 150 addressable points per loop 400mA max current per loop	4 loops 150 addressable points per loop 400mA max current per loop
Conventional sounder / siren circuits	4 x 24V _{DC} (± 3V _{DC}) / 300mA max short / open circuit monitored 10kΩ termination resistor		
24VP Output	24V _{DC} (± 3V _{DC}) permanent output / 300mA max short-circuit monitored		
24VM Output	24V _{DC} (± 3V _{DC}) resettable output / 300mA max short-circuit monitored		
FAULT / ALARM / AUX Relays	potential free contacts, rated at 30V _{DC} / 5A max (resistive load) all output relays must be protected by appropriate fuses externally dependent to the circuit's characteristics		
Total load	2A max (including loop devices, conventional sirens, 24VM/VP outputs)		
Autonomy (on battery)	up to 72 hours (without loads at 24VM and 24VP outputs) depending on batteries		
Battery cut-off voltage	20,5V		
Battery discharge current	2A max		
Battery resistance (ESR)	1Ω max (higher values will lead to battery resistance fault)		
Ingress protection (case)	IP 30		
Compatible cables	Cables for fire detection systems such as FIP200, MICC, PYROFIL		
USB connection	Mini USB-B (2.0)		

 olympia electronics <small>SAFETY & SECURITY SYSTEMS</small> <i>for a safer world!</i>	Date	9/6/2022
	Document number	921100400_09_005
	Page	70 of 71

Fuse type	Mains input: 4A/250V (Fast) TR5 – non replaceable Battery: 900mA self resettable – non replaceable		
Operating temperature	-5 to 40 °C		
Relative humidity	Up to 95% non-condensing		
Construction materials	ABS – polycarbonate / metal sheet with electrostatic paint		
Dimensions (LxWxH)	355 x 115 x 345 mm		
Weight (without batteries)	4,08kg	4,21kg	4,33kg
Manufactured in accordance with	EN 54-2, EN 54-4		
Warranty	2 years		
Design	This device's materials are selected according to the scope of use, meeting the required specifications for operating environment conditions in compliance with 3K5 EN-60721-3-3: 1995.		

9.1 Factory default settings

Registered points	None
Conventional sirens	All outputs enabled on general alarm, no delay
AUX relay	Enabled on general alarm, positive logic, no delay (NO – C contacts active on alarm)
Extra relays	Enabled on general alarm, positive logic, no delay
Tasks	All deactivated
Enabled / disabled segments	All segments enabled (zones, points, sirens, etc.)
Working hours	05:00 until 23:00
Working days	Monday, Tuesday, Wednesday, Thursday, Friday
Panel address (panels network)	2
Buzzer	Enabled
Screen backlight	Power saving
Delays (general)	Enabled
Indication of points	Enabled
User code	1000
Technician code	1111
Max indicators per loop	10
Detector DAY alarm limit	100
Detector NIGHT alarm limit	100

 olympia electronics <small>SAFETY & SECURITY SYSTEMS</small> <i>for a safer world!</i>	Date	9/6/2022
	Document number	921100400_09_005
	Page	71 of 71

IMPORTANT! Resetting to factory defaults will not alter settings for loops enabled, Ethernet adaptor configuration and MODBUS / Printer external PCB function.

9.2 EN 54-2 implemented optional paragraphs

7.8	Output to fire alarm device(s)
7.9.1	Output to fault warning routing equipment
7.11	Delays to outputs
7.12.1	Type A detectors dependency
7.13	Alarm counter
8.3	Fault signals from points
9.5	Disablement of each address point
10	Test condition

WARRANTY

Olympia Electronics guarantees the quality, condition and operation of the goods. The period of warranty is specified in the official catalogue of Olympia Electronics and also in the technical leaflet, which accompanies each product. This warranty ceases to exist if the buyer does not follow the technical instructions included in official documents given by Olympia Electronics or if the buyer modifies the goods provided or has any repairs or re-setting done by a third party, unless Olympia Electronics has fully agreed to them in writing. Products that have been damaged can be returned to the premises of our company for repair or replacement, as long as the warranty period is valid.

Olympia Electronics reserves the right to repair or to replace the returned goods and to or not charge the buyer depending on the reason of deflection. Olympia Electronics reserves the right to charge or not the buyer the transportation cost.

HEAD OFFICE

72nd km. O.N.R. Thessaloniki-Katerini
P.C. 60300 P.O. Box 06 Eginio Pierias Greece

www.olympia-electronics.com

info@olympia-electronics.gr